

# CipherLab Reference Manual

8400 Series Mobile Computer

8400/8470

Version 1.10



Copyright © 2009~2011 CIPHERLAB CO., LTD.  
All rights reserved

The software contains proprietary information of CIPHERLAB CO., LTD.; it is provided under a license agreement containing restrictions on use and disclosure and is also protected by copyright law. Reverse engineering of the software is prohibited.

Due to continued product development this information may change without notice. The information and intellectual property contained herein is confidential between CIPHERLAB and the client and remains the exclusive property of CIPHERLAB CO., LTD. If you find any problems in the documentation, please report them to us in writing. CIPHERLAB does not warrant that this document is error-free.

No part of this publication may be reproduced, stored in a retrieval system, or transmitted in any form or by any means, electronic, mechanical, photocopying, recording or otherwise without the prior written permission of CIPHERLAB CO., LTD.

For product consultancy and technical support, please contact your local sales representative. Also, you may visit our web site for more information.

The CipherLab logo is a registered trademark of CIPHERLAB CO., LTD.

All brand, product and service, and trademark names are the property of their registered owners.

The editorial use of these names is for identification as well as to the benefit of the owners, with no intention of infringement.

**CIPHERLAB CO., LTD.**

Website: <http://www.cipherlab.com>

# IMPORTANT NOTICES

---

## FOR USA

This equipment has been tested and found to comply with the limits for a **Class B** digital device, pursuant to Part 15 of the FCC Rules. These limits are designed to provide reasonable protection against harmful interference in a residential installation. This equipment generates, uses and can radiate radio frequency energy and, if not installed and used in accordance with the instructions, may cause harmful interference to radio communications. However, there is no guarantee that interference will not occur in a particular installation. If this equipment does cause harmful interference to radio or television reception, which can be determined by turning the equipment off and on, the user is encouraged to try to correct the interference by one or more of the following measures:

- ▶ Reorient or relocate the receiving antenna.
- ▶ Increase the separation between the equipment and receiver.
- ▶ Connect the equipment into an outlet on a circuit different from that to which the receiver is connected.
- ▶ Consult the dealer or an experienced radio/TV technician for help.

This device complies with Part 15 of the FCC Rules. Operation is subject to the following two conditions: (1) This device may not cause harmful interference, and (2) this device must accept any interference received, including interference that may cause undesired operation.

## FOR CANADA

This digital apparatus does not exceed the Class B limits for radio noise emissions from digital apparatus as set out in the interference-causing equipment standard entitled "Digital Apparatus," ICES-003 of Industry Canada.

This device complies with Part 15 of the FCC Rules. Operation is subject to the following two conditions: (1) This device may not cause harmful interference, and (2) this device must accept any interference received, including interference that may cause undesired operation.

Cet appareil numérique respecte les limites de bruits radioélectriques applicables aux appareils numériques de Classe B prescrites dans la norme sur le matériel brouilleur: "Appareils Numériques," NMB-003 édictée par l'Industrie.

## FOR HAND-HELD PRODUCT WITH RF FUNCTIONS

This equipment complies with FCC radiation exposure limits set forth for an uncontrolled environment. This equipment should be installed and operated with minimum distance 20 cm between the radiator & your body. It only operated in hand-held used.

If you only transfer data to the host wirelessly, please keep the minimum distance 20 cm between machine & your body.

## FOR PRODUCT WITH LASER



### CAUTION

**This laser component emits FDA / IEC Class 2 laser light at the exit port. Do not stare into beam.**

## SAFETY PRECAUTIONS

**RISK OF EXPLOSION IF BATTERY IS REPLACED BY AN INCORRECT TYPE. DISPOSE OF USED BATTERIES ACCORDING TO THE INSTRUCTIONS.**

- ▶ The use of any batteries or charging devices, which are not originally sold or manufactured by CipherLab, will void your warranty and may cause damage to human body or the product itself.
- ▶ DO NOT disassemble, incinerate or short circuit the battery.
- ▶ DO NOT expose the scanner or the battery to any flammable sources.
- ▶ For green-environment issue, it's important that batteries should be recycled in a proper way.
- ▶ Under no circumstances, internal components are self-serviceable.
- ▶ The charging and communication cradle uses an AC power adaptor. A socket outlet shall be installed near the equipment and shall be easily accessible. Make sure there is stable power supply for the mobile computer or its peripherals to operate properly.

## CARE & MAINTENANCE

- ▶ This mobile computer is intended for enterprise logistics use. The mobile computer is rated IP 54, however, it may do damage to the mobile computer when being exposed to extreme temperatures or soaked wet.
- ▶ When the body of the mobile computer gets dirty, use a clean and wet cloth to wipe off the dust. DO NOT use/mix any bleach or cleaner. Always keep the LCD dry.
- ▶ For a liquid crystal display (LCD), use a clean, non-abrasive, lint-free cloth to wipe dust off the screen. DO NOT use any pointed or sharp object to move against the surface.
- ▶ If you want to put away the mobile computer for a period of time, download the collected data to a host computer, and then take out the battery pack. Store the mobile computer and battery pack separately.
- ▶ When the mobile computer resumes its work, the main and backup batteries will take a certain time to become fully charged.
- ▶ If you shall find the mobile computer malfunctioning, write down the specific scenario and consult your local sales representative.

# RELEASE NOTES

---

| Version | Date          | Notes   |
|---------|---------------|---|
| 1.10    | Mar. 09, 2011 | <ul style="list-style-type: none"><li>▶ Modified: 1.7.2 Cradle Options — update illustration</li><li>▶ Modified: Chapter 2 — update screenshots</li><li>▶ Modified: Specifications — add power adaptor spec.</li></ul>  |
| 1.09    | Oct. 28, 2010 | <ul style="list-style-type: none"><li>▶ Modified: Appendix III — update key reference tables</li></ul>  |
| 1.08    | Oct. 20, 2010 | <ul style="list-style-type: none"><li>▶ Modified: 3.7 Bluetooth Menu — update table (add HID)</li></ul>   |
| 1.07    | Sep. 09, 2010 | <ul style="list-style-type: none"><li>▶ Modified: 1.6 Data Capture — add more GS1 DataBar symbologies</li><li>▶ Modified: 3.7.6 Frequent Devices</li></ul>  |
| 1.06    | Aug. 26, 2010 | <ul style="list-style-type: none"><li>▶ Modified: 1.6 Data Capture — add Coop 25 (CCD/Laser)</li><li>▶ Modified: 1.8 SD Card — BASIC runtime incompatibility issue, etc.</li><li>▶ Modified: 2.1.1 FORGE Application Generator (AG) — on-screen moving hourglass icon indicates support of auto upload</li><li>▶ Modified: 3.7 Bluetooth Menu — update screenshots</li><li>▶ Modified: 3.7.5 Pairing Test — max. 11 characters for device name</li><li>▶ Modified: 3.7.6 Freq. Dev. List — max. 11 characters for device name</li></ul> |
| 1.05    | May 31, 2010  | <ul style="list-style-type: none"><li>▶ Modified: Getting Started — Initial Charging (battery charging fails when out of temperature range 0°C ~40°C)</li><li>▶ Modified: 1.6 Data Capture — UPC/EAN Addon 2 &amp; 5 disabled by default for 2D, (Extra) Long Range</li><li>▶ Modified: 1.7 Charging &amp; Communications (battery charging fails when out of temperature range 0°C ~40°C)</li><li>▶ Modified: 3.11.5 Echo Tests — Wi-Fi signal table</li></ul>   |
| 1.04    | Mar. 09, 2010 | <ul style="list-style-type: none"><li>▶ Modified: 3.6 Load Program — 8400 timeouts within 30 sec.</li><li>▶ Modified: 3.8 SD Card Menu — AG working directories</li><li>▶ Modified: 4.1.3 Upload — USB Virtual COM available for uploading to PC</li><li>▶ Modified: 4.2.2 Load Program — 8400 timeouts within 30 sec.</li></ul>  |
| 1.03    | Jan. 20, 2010 | <ul style="list-style-type: none"><li>▶ Modified: Accessories — supports 308 Virtual COM Interface cable</li></ul>  |

- |      |               |   |
|------|---------------|---|
| 1.02 | Oct. 30, 2009 | <ul style="list-style-type: none"> <li>▶ Modified: 1.1.2 Backup Battery — 3.0 V/18 mAh (72 hrs.)</li> <li>▶ Modified: 1.6 Data Capture — Chinese 25 disabled by default; ISBT 128 enabled by default</li> <li>▶ Modified: 1.7.1 Interface Cable Options — update illustration</li> <li>▶ Modified: 1.7.2 Cradle Options — update GPRS Cradle illustration; add note "Tighten the two screw-in connectors to secure the cable."</li> <li>▶ Modified: 3.2 Settings — update illustration</li> <li>▶ New: 3.2.13 Reset Reader</li> <li>▶ New: 3.2.14 Upgrade Reader FW</li> <li>▶ Modified: Specifications — Backup Battery changed to 3.0 V/18 mAh</li> </ul> |
| 1.01 | Aug. 18, 2009 | <ul style="list-style-type: none"> <li>▶ Modified: 1.2.3 SD Card</li> <li>▶ Modified: 3.8.1 Run as USB Disk — 30 seconds or longer for PC to detect</li> <li>▶ Modified: 3.8.2 Access SD Card — add "Check Memory"</li> </ul>   |
| 1.00 | July 20, 2009 | Initial release   |

# CONTENTS

---

- IMPORTANT NOTICES ..... - 3 -**
  - For USA ..... - 3 -
  - For Canada ..... - 3 -
  - For Hand-held Product with RF Functions ..... - 3 -
  - For Product with Laser ..... - 4 -
  - Safety Precautions ..... - 4 -
  - Care & Maintenance ..... - 4 -
  
- RELEASE NOTES ..... - 5 -**
  
- INTRODUCTION ..... 1**
  - Getting Familiarized with 8400 ..... 2
  - Features ..... 3
  - Inside the Package ..... 3
  - Accessories ..... 3
  - Getting Started ..... 4
    - Inserting Battery & Memory Card ..... 4
    - Initial Charging ..... 6
    - Setting Local Time ..... 6
    - Power Management ..... 6
  
- USING 8400 MOBILE COMPUTER ..... 7**
  - 1.1 Battery ..... 7
    - 1.1.1 Main Battery ..... 7
    - 1.1.2 Backup Battery ..... 8
    - 1.1.3 Caution of Low Battery Charge ..... 8
  - 1.2 Memory ..... 9
    - 1.2.1 Read-only Memory (ROM) ..... 9
    - 1.2.2 Random-access Memory (RAM) ..... 9
    - 1.2.3 SD Card ..... 9
  - 1.3 Keypad ..... 10
    - 1.3.1 29-key Layout ..... 10
    - 1.3.2 39-key Layout ..... 14
  - 1.4 LCD ..... 18
    - 1.4.1 Adjusting the Backlight ..... 18
  - 1.5 Notifications ..... 19
    - 1.5.1 Status LED ..... 19
    - 1.5.2 Audio ..... 20
    - 1.5.3 Vibrator ..... 20
  - 1.6 Data Capture ..... 21
  - 1.7 Charging & Communications ..... 23
    - 1.7.1 Interface Cable Options ..... 24
    - 1.7.2 Cradle Options ..... 25

|  |           |
|--|-----------|
| 1.7.3 4-Slot Battery Charger .....           | 28        |
| 1.8 SD Card .....                            | 29        |
| 1.8.1 File System .....                      | 29        |
| 1.8.2 Directory.....                         | 29        |
| 1.8.3 File Name.....                         | 31        |
| <b>LEARNING SOFTWARE ARCHITECTURE.....</b>   | <b>33</b> |
| 2.1 Application Module.....                  | 35        |
| 2.1.1 FORGE Application Generator (AG) ..... | 35        |
| 2.1.2 MIRROR Emulator (CipherNet) .....      | 36        |
| 2.1.3 User Program.....                      | 36        |
| 2.2 System Configuration & Core.....         | 37        |
| 2.2.1 System Menu.....                       | 37        |
| 2.2.2 Kernel .....                           | 37        |
| 2.2.3 Program Manager .....                  | 37        |
| <b>SYSTEM MENU.....</b>                      | <b>39</b> |
| 3.1 Information.....                         | 40        |
| 3.1.1 Understanding Device Code .....        | 41        |
| 3.2 Settings .....                           | 42        |
| 3.2.1 Clock .....                            | 42        |
| 3.2.2 Backlight .....                        | 42        |
| 3.2.3 Contrast .....                         | 43        |
| 3.2.4 Auto Off .....                         | 43        |
| 3.2.5 Power On (& Wakeup Event) Options..... | 43        |
| 3.2.6 Key Click .....                        | 44        |
| 3.2.7 Buzzer Volume.....                     | 44        |
| 3.2.8 USB VCOM No.....                       | 44        |
| 3.2.9 USB Charge Current .....               | 44        |
| 3.2.10 Font.....                             | 44        |
| 3.2.11 System Password.....                  | 45        |
| 3.2.12 Reset to Default .....                | 45        |
| 3.2.13 Reset Reader .....                    | 45        |
| 3.2.14 Upgrade Reader FW.....                | 45        |
| 3.3 Tests .....                              | 46        |
| 3.3.1 Reader .....                           | 46        |
| 3.3.2 Buzzer .....                           | 46        |
| 3.3.3 LCD & LED .....                        | 46        |
| 3.3.4 Keyboard.....                          | 46        |
| 3.3.5 Memory .....                           | 46        |
| 3.3.6 Echo Test .....                        | 47        |
| 3.3.7 Vibrator .....                         | 47        |
| 3.4 Memory .....                             | 48        |
| 3.4.1 Size information .....                 | 48        |
| 3.4.2 Initialize.....                        | 48        |
| 3.5 Power.....                               | 49        |
| 3.6 Load Program .....                       | 50        |
| 3.7 Bluetooth Menu .....                     | 53        |
| 3.7.1 Information .....                      | 54        |
| 3.7.2 Connect Setting.....                   | 55        |
| 3.7.3 Security .....                         | 56        |



|  |           |
|--|-----------|
| 3.7.4 Echo Tests .....                       | 57        |
| 3.7.5 Pairing Test.....                      | 60        |
| 3.7.6 Frequent Devices .....                 | 61        |
| 3.8 SD Card Menu.....                        | 62        |
| 3.8.1 Run as USB Disk .....                  | 62        |
| 3.8.2 Access SD Card .....                   | 62        |
| 3.9 Ethernet Cradle Menu .....               | 64        |
| 3.9.1 Information .....                      | 64        |
| 3.9.2 Network Setting.....                   | 65        |
| 3.9.3 Echo Tests .....                       | 66        |
| 3.10 Serial PPP Menu.....                    | 67        |
| 3.10.1 Information.....                      | 67        |
| 3.10.2 Connection Set.....                   | 68        |
| 3.10.3 Echo Test.....                        | 69        |
| 3.11 Wi-Fi Menu .....                        | 70        |
| 3.11.1 Information.....                      | 71        |
| 3.11.2 Network Setting .....                 | 72        |
| 3.11.3 WLAN Setting .....                    | 73        |
| 3.11.4 Security.....                         | 75        |
| 3.11.5 Echo Tests.....                       | 76        |
| <b>PROGRAM MANAGER &amp; KERNEL .....</b>    | <b>79</b> |
| 4.1 Program Manager.....                     | 79        |
| 4.1.1 Download .....                         | 80        |
| 4.1.2 Activate .....                         | 82        |
| 4.1.3 Upload.....                            | 83        |
| 4.2 Kernel.....                              | 84        |
| 4.2.1 Kernel Information .....               | 85        |
| 4.2.2 Load Program .....                     | 86        |
| 4.2.3 Kernel Update .....                    | 89        |
| 4.2.4 Test & Calibrate.....                  | 90        |
| 4.2.5 Bluetooth Menu.....                    | 90        |
| <b>SPECIFICATIONS .....</b>                  | <b>91</b> |
| <b>DOWNLOAD UTILITY.....</b>                 | <b>93</b> |
| File Types .....                             | 93        |
| Font File .....                              | 93        |
| C Programs .....                             | 93        |
| BASIC Programs .....                         | 93        |
| ProgLoad.exe.....                            | 94        |
| <b>TROUBLESHOOTING .....</b>                 | <b>95</b> |
| Cannot turn on when pressing Power key ..... | 95        |
| Charging error.....                          | 95        |
| Buzzer seems not working.....                | 95        |
| LED indicators seem not working.....         | 95        |
| LCD seems not working .....                  | 95        |
| Keypad seems not working .....               | 96        |

|  |           |
|--|-----------|
| Vibrator seems not working.....        | 96        |
| Mobile computer seems not working..... | 96        |
| Cannot scan barcodes .....             | 96        |
| Low battery condition.....             | 96        |
| Barcode reader problem.....            | 96        |
| Cannot decode data after scanning..... | 96        |
| Unreadable barcode .....               | 96        |
| Un-programmed to read .....            | 96        |
| Dirty scan window .....                | 96        |
| Out of scanning range.....             | 97        |
| Cannot transmit/receive data .....     | 97        |
| Using RS-232 cable .....               | 97        |
| Using USB cable .....                  | 97        |
| Via Bluetooth .....                    | 97        |
| Via Wi-Fi .....                        | 97        |
| Via Ethernet Cradle .....              | 98        |
| Via Modem Cradle.....                  | 98        |
| <b>KEY REFERENCE TABLES .....</b>      | <b>99</b> |
| 29-key Keypad.....                     | 99        |
| System Defaults .....                  | 99        |
| Extended Function Keys .....           | 100       |
| 39-key Keypad.....                     | 101       |
| System Defaults .....                  | 101       |

# INTRODUCTION

---

Answering industrial demands for ruggedized, light-weight and versatile computers, the 8400 Series Mobile Computer is specifically designed for enterprise logistics use.

This line of product comes with built-in Bluetooth technology and allows for optional module for 802.11b/g connectivity, enabling real time sharing of performance.

The 8400 Series Mobile Computer is bundled with powerful and rich features to ensure success in timely processing of information, and thus, makes an ideal choice for inventory control, shop floor management, warehousing and distribution operations. Being programmable, this handy device can run custom applications or terminal emulation applications.

This manual serves to guide you through how to install, configure, and operate the mobile computer. We recommend you to keep one copy of the manual at hand for quick reference or maintenance purposes. To avoid any improper disposal or operation, please read the manual thoroughly before use.

Thank you for choosing CipherLab products!

GETTING FAMILIARIZED WITH 8400

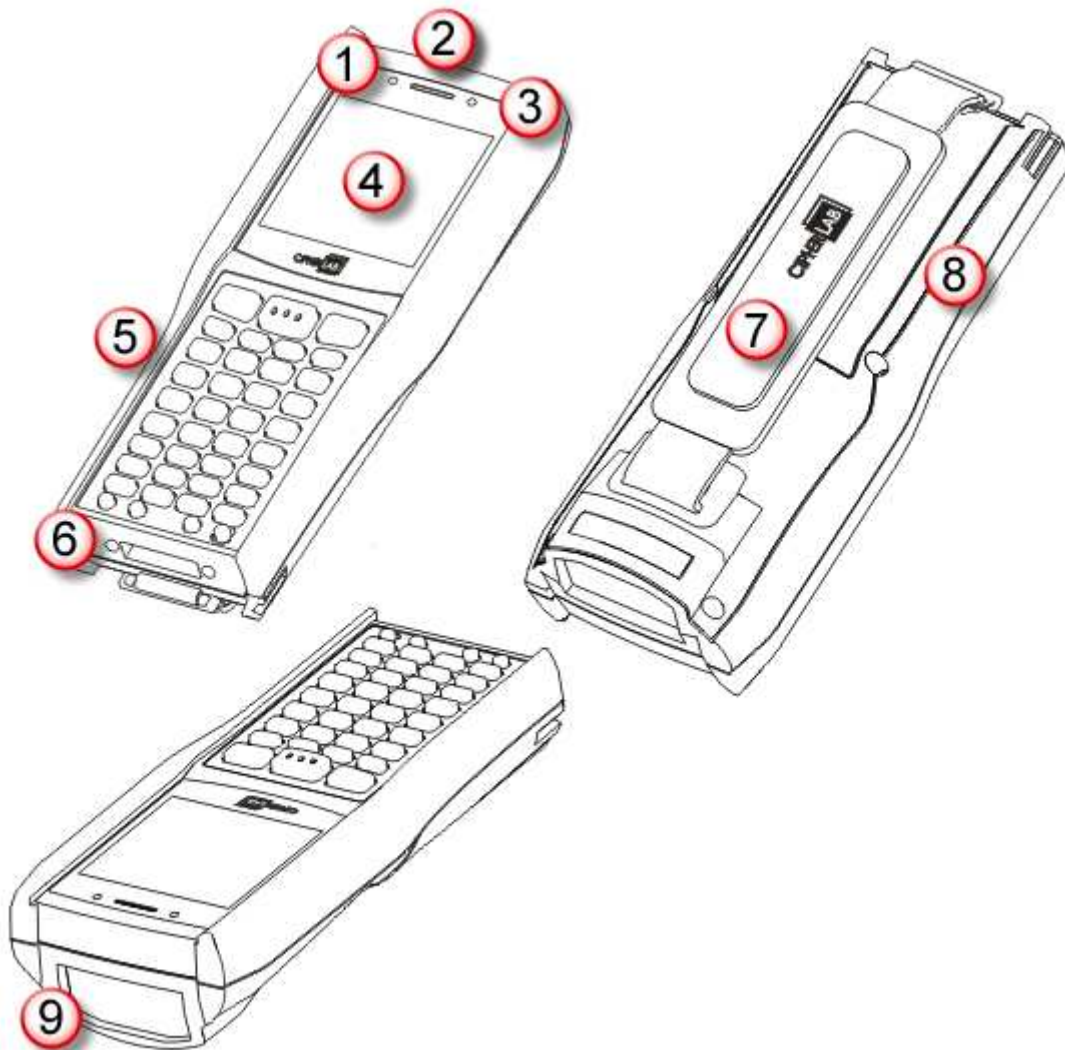

Figure 1: Overview

| No. | Description                            | No. | Description                 |
|-----|--|-----|-----------------------------|
| 1   | LED for Good Read and battery charging | 2   | Buzzer                      |
| 3   | LED for wireless communications        | 4   | LCD screen                  |
| 5   | Keypad, 29 or 39 keys                  | 6   | Communication/charging port |
| 7   | Hand strap                             | 8   | Battery compartment         |
| 9   | Scanning window                        |     |                             |

**Warning:** Always make sure the hand strap is well hooked and screwed to the back of the mobile computer before use.

## FEATURES

- ▶ Ergonomic design — ruggedized yet streamlined, with hand strap for secure hold
- ▶ Built tough to survive drop test and sealed against moisture/dust to IP 54
- ▶ Rich interface options — USB or RS-232 (cable), plus modem, Ethernet or GSM/GPRS (via cradle)
- ▶ Up to 8 GB high capacity memory card (microSDHC) supported
- ▶ Flexible wireless solutions — Bluetooth or 802.11b/g
- ▶ Graphic monochrome LCD supports double-byte characters and bitmap graphics
- ▶ Programmable feedback includes buzzer, LED indicators and vibrator
- ▶ Quick link to any backend database through MIRROR Emulator programs for VT100/220 and IBM 5250 emulation
- ▶ Easy customization of data collection applications through FORGE Application Generator (AG) programs for preloaded AG Runtime, batch and WLAN versions available
- ▶ Programming support includes BASIC & C compilers
- ▶ Accessories include RS-232 cable, 4-Slot Battery Charger and a variety of charging/communications cradle, etc.

## INSIDE THE PACKAGE

The following items are included in the package. Save the box and packaging material for future use in case you need to store or ship the mobile computer.

- ▶ 8400 Series mobile computer
- ▶ Rechargeable Li-ion battery pack
- ▶ Hand strap
- ▶ Standard USB cable
- ▶ Universal power adaptor
- ▶ Product CD

## ACCESSORIES

Rich choices of optional accessories are available for you to enhance the total performance of the mobile computer.

- ▶ Protective Cover
- ▶ Spare rechargeable Li-ion battery
- ▶ 4-slot Battery Charger
- ▶ RS-232 Cable
- ▶ 308 USB Virtual COM Interface Cable (convert RS-232 to USB)
- ▶ Charging & communication Cradle
- ▶ Modem Cradle
- ▶ Ethernet Cradle (10/100 BASE-T)
- ▶ GPRS/GSM Cradle (EDGE/Quad-band)

## GETTING STARTED

### INSERTING BATTERY & MEMORY CARD

For shipping and storage purposes, save the mobile computer and the main battery in separate packages. This will keep both batteries in good condition for future use.

---

**Note:** Any improper handling may reduce the battery life.

---

- 1) Unhook the hand strap from the bottom of the mobile computer. Make sure to turn off the mobile computer.
- 2) Hold the mobile computer still and press the release button to unlock the battery cover.
- 3) Slide off the battery cover.
- 4) Use your finger to slide the locking plate towards its hinge to unlock the SD card holder.
- 5) Flip up the SD card holder.
- 6) Insert your memory card (microSD or microSDHC) to the SD card holder.
- 7) Push the SD card holder down.
- 8) Slide the locking plate away from its hinge to secure the card.
- 9) Slide the battery pack into the battery compartment at a proper angle (30°~45°) so that the tabs on the bottom of the battery are hooked in the grooves of the compartment.
- 10) Push down the battery and make sure that the battery is snugly fit into the compartment.
- 11) Slide the battery cover back onto the mobile computer until it clicks into place.

---

**Note:** For a new battery, make sure it is fully charged before use. Always prepare a spare battery pack, especially when you are on the road.

---

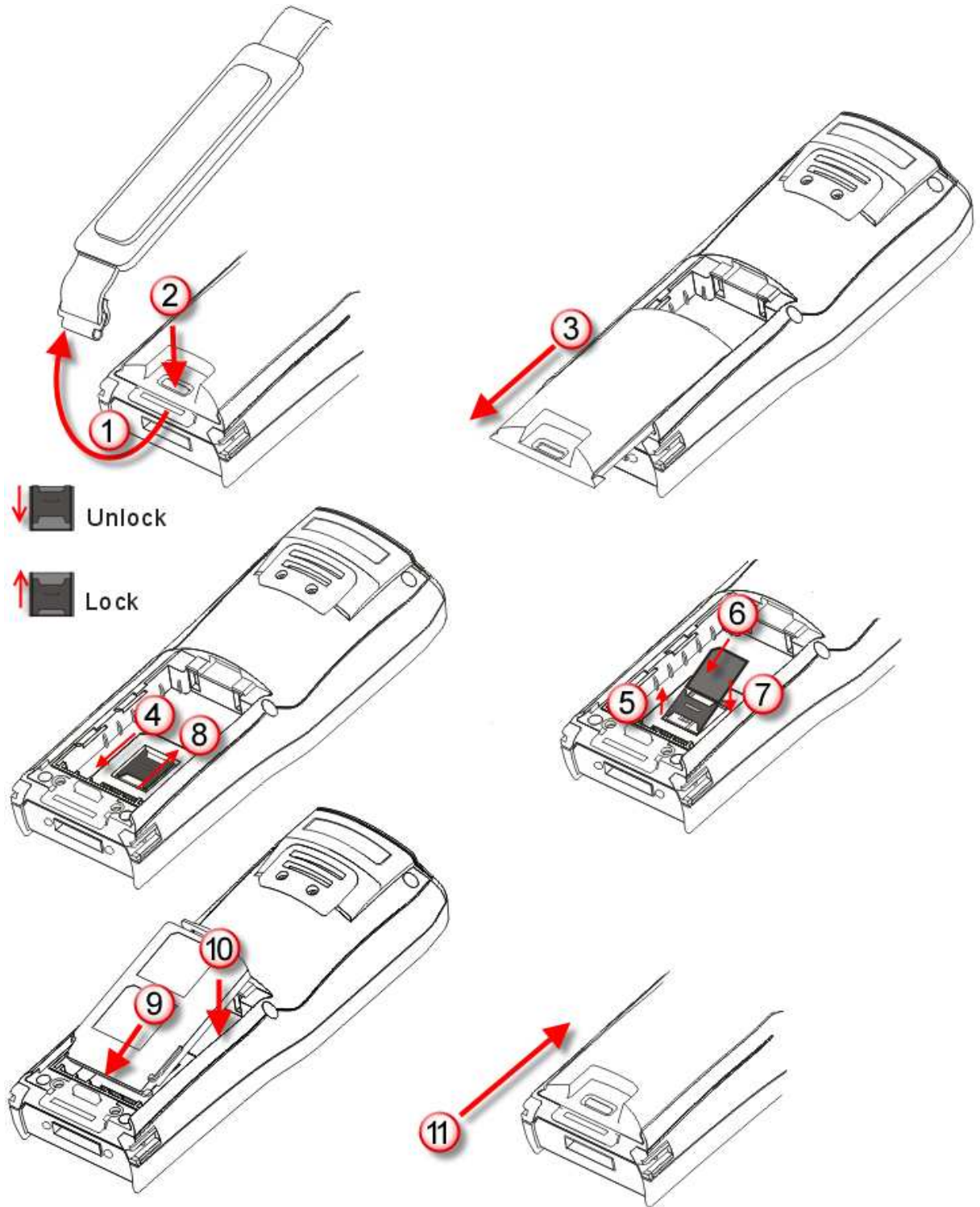

Figure 2: Installing the Main Battery & Memory Card

## INITIAL CHARGING

The main and backup batteries may not be charged to full for shipment. When you first receive the package, you will need to charge the main battery to full before using the mobile computer. Instead of direct charging, you may use a cradle or charger to charge the Mobile Computer or spare batteries. Refer to [1.7 Charging & Communications](#).

---

Note: Battery charging stops when the temperature drops below 0°C or exceeds 40°C. It is recommended to charge the battery at room temperature (18°C to 25°C) for optimal performance. For initial charging, it takes approximately 4~5 hours to charge the battery to full (from the adaptor).

---

Because the internal backup battery is constantly charged from the main battery, the initial charging requires inserting the battery pack to the mobile computer for charging. This will have both the main and backup batteries charged at the same time. It takes at least 72 hours to fully charge the backup battery. However, it is not necessary to fully charge the backup battery for the mobile computer to work.

---

Note: In order to charge the backup battery to full, you must insert the main battery and leave it for at least 72 hours, whether the mobile computer is in use or not.

---

## SETTING LOCAL TIME

If you need to set your local time, go to **System Menu | 2. Settings | 1. Clock**. Refer to [3.2.1 Clock](#).

## POWER MANAGEMENT

For any portable device, power management is a critical issue especially when you are on the road. Below are some tips to help you save battery power.

---

Warning: Using backlight, wireless connectivity, and peripherals while on battery power will substantially reduce battery power.

---

- ▶ To speed up charging the mobile computer, turn off the mobile computer and seat it in the cradle or use the charging/communication cable.
- ▶ Bring a second battery pack on the road.
- ▶ Stop wireless connectivity, Bluetooth or 802.11b/g that is not in use.
- ▶ Go to **System Menu | 2. Settings | 2. Backlight**, and configure backlight period, luminosity, as well as the shade effect. Refer to [3.2.2 Backlight](#).
- ▶ Go to **System Menu | 2. Settings | 4. Auto Off**, and configure the amount of idle time that must pass before the system will shut down automatically. Refer to [3.2.4 Auto Off](#).



## USING 8400 MOBILE COMPUTER

---

This chapter explains the features and usage of the 8400 Series Mobile Computer. The 8400 family includes:

- ▶ 8400 Bluetooth Class 2
- ▶ 8470 Bluetooth Class 2 + 802.11b/g

### IN THIS CHAPTER

---

|                                    |    |
|------------------------------------|----|
| 1.1 Battery.....                   | 7  |
| 1.2 Memory.....                    | 9  |
| 1.3 Keypad.....                    | 10 |
| 1.4 LCD .....                      | 18 |
| 1.5 Notifications.....             | 19 |
| 1.6 Data Capture .....             | 21 |
| 1.7 Charging & Communications..... | 23 |
| 1.8 SD Card .....                  | 29 |

### 1.1 BATTERY

#### 1.1.1 MAIN BATTERY

The mobile computer is powered by a rechargeable 3.7 V/1800 mAh Li-ion battery pack. When the mobile computer is turned on, it takes approx. 4 hours to charge it to full from the power adaptor (using RS-232 cable or cradle) or approx. 5 hours from the USB cable (at 500 mA).

For power-saving purpose, always turn off the backlight while working in a well-lit area. When the backlight is on for extended periods of time, the main battery will become low sooner than expected.

The smart battery icon on the LCD screen shows the status of power consumption. There are two ways to monitor a low battery charge or discharged battery from the screen.

- ▶ Examine the level of the 4-bar battery icon
- ▶ Monitor voltage level (see [3.5 Power](#))

### 1.1.2 BACKUP BATTERY

The backup battery on the main board takes charge when the main battery is removed or drained out. When fully charged, the 3.0 V/18 mAh rechargeable Lithium button cell helps retain data in SRAM and maintain the running of the real-time clock and calendar for at least 25 days without the main battery. In the meantime, you have to replace the main battery as soon as possible. It takes at least 72 hours to fully charge the backup battery. However, it is not necessary to fully charge the backup battery for the mobile computer to work.

- ▶ Monitor voltage level (see [3.5 Power](#))

### 1.1.3 CAUTION OF LOW BATTERY CHARGE

The battery pack is the only power source for the mobile computer to work. It also charges the backup battery on the main board so that the data stored in SRAM can be retained properly. Therefore, when the main battery charge goes low, you need to replace the battery pack with a charged one or charge it as soon as possible. Most of all, you should upload important data on a regular basis.

---

**Warning:** Data loss may occur with SRAM during low battery condition. Always save data before running out of power or keep a fresh battery for replacement.

---

## 1.2 MEMORY

The collected data can be sent back to a host computer immediately over wireless networks, or stored in memory (SRAM) and upload later. The mobile computer is equipped with a calendar chip for accurate time/date logging. When the main battery is removed or drained, the backup battery on the main board is to retain the contents of SRAM and maintain the running of real-time clock and calendar for at least 25 days, on condition that the backup battery has already been fully charged.

If you want to put away the mobile computer for a couple of days, you should be aware that data loss occurs when both the main and backup batteries discharge completely. Therefore, it is necessary to upload data and files before putting away the mobile computer!

### 1.2.1 READ-ONLY MEMORY (ROM)

4 megabytes flash memory for storing core, OS, application programs, font, etc.

### 1.2.2 RANDOM-ACCESS MEMORY (RAM)

Options include 4 or 16 megabytes SRAM for storing data. Its contents will be retained by the backup battery.

### 1.2.3 SD CARD

Secure Digital (SD) card is a flash memory data storage device. Up to 8 GB high capacity memory card (microSDHC) is supported. Refer to [Inserting Battery & Memory Card](#) for how to insert the microSD or microSDHC card. For more details, refer to [1.8 SD Card](#).

---

Note: (1) When SD card is present, the card icon will appear on the screen and flash while being accessed.  
(2) For an SD card that has never been used on 8400, a message like "Found New SD Card" will be displayed allowing users to scan the card for memory check. If the action is canceled then, memory check can still be performed via System Menu — [3.8 SD Card Menu](#).

---

## 1.3 KEYPAD

The mobile computer can be equipped with a keypad of 29 keys or 39 keys for system setup, user entry and so on. The keypad comes with programmable LED backlight, like the screen. Refer to [1.4 LCD](#) for screen & backlight settings.

Silicon rubber has been chosen for their durability and prompt feedback. The key click can be configured through programming or via **System Menu**. Refer to [3.2.6 Key Click](#).

### 1.3.1 29-KEY LAYOUT

The layout of the 29-key keypad is similar to that of a telephone, which includes alphanumeric, navigation and function keys, as well as assorted characters and two modifier keys. Refer to [Appendix III — Key Reference Tables](#) for color-coded keys.





Figure 3: 29-key Layout

This alphanumeric keypad is set to numeric mode by default. The blue modifier key  serves as a toggle among numeric, alpha (lower-case alphabetic), and ALPHA (upper-case alphabetic) input modes.

Note: It is not necessary to hold down the blue modifier key.



The alpha icon will appear on the lower-left corner of the screen in a sequence as shown below.

| Status Icon | Alpha Key   | Input Mode            |
|-------------|---|-----------------------|
| (none)      | N/A   | Numbers               |
| <b>A</b>    | Press  one time  | Upper-case alphabetic |
| <b>a</b>    | Press  two times | Lower-case alphabetic |

When in alpha mode, it takes turns to show alphabets and number when you keep pressing the same key; each press must not exceed one second. For example, keep pressing the number key [2], it will take turns to show "A", "B", "C" or "2" for upper-case, and "a", "b", "c" or "2" for lower-case.

- ▶ When you first press the number key [2], it will produce the letter "A" or "a".
- ▶ When you press the number key [2] twice (the time interval must not exceed one second), it will produce the letter "B" or "b".
- ▶ When you press the number key [2] three times (the time interval between each press must not exceed one second), it will produce the letter "C" or "c".
- ▶ When you press the number key [2] four times (the time interval between each press must not exceed one second), it will produce the number "2".

In order to get the desired character, you will need to press the same key, one to four times (the time interval between each press must not exceed one second). Only when you stop pressing the same key for longer than one second or you press another key, will the system send the real key code to the application program.

The orange modifier key  works with a key on which orange-coded function or character is printed at the upper-right corner. Press the orange key, and its associated icon  will be displayed on the screen. Press the second key, say [F1], to complete the key combination and access the function [F5]. The icon  will go off automatically.

Orange-coded function or character printed at the upper-right corner



Below briefly describes the functions of common keys on the mobile computer.

### SCAN



This yellow key is used to trigger the scan engine so that it can read a barcode when the reader function is enabled.

### ENTER



This key is on the right side of the **SCAN** key. Normally, it is used for command execution or input confirmation.

### ESC (Escape)



This key is on the left side of the **SCAN** key. Normally, it is used to stop and exit the current operation.

### Navigation Keys



These keys are used to move the cursor left, up, down, or right.



- ▶ While pressing , they can be used to adjust the luminosity and contrast of the screen backlight.

### BkSp (Backspace)











This key is **Backspace** by default. If this key is being held down for more than one second, a `clear` code will be sent.

- ▶ While pressing the key along with the orange modifier key , it becomes the **Delete** key.

### Backlight Configuration Key



This key is used to turn ON/OFF the backlight of the LCD and keypad. Also, while pressing , the navigation keys can be used to adjust the luminosity and contrast of the screen backlight.

| Key   | Description   |
|---|---|
|   | Press these keys at the same time to increase the contrast.   |
|   | Press these keys at the same time to decrease the contrast.   |
|   | Press these keys at the same time to increase the luminosity. |
|   | Press these keys at the same time to decrease the luminosity. |

### Orange Modifier Key



This key is a modifier key that requires pressing a second key to get the orange-coded function (F5~F8, Tab, Del) printed on the upper-right corner of the second key.

| Icon | Description  |
|------|--|
|      | <p>By default, the function toggle is set to Auto Resume mode, and its behavior is as described below:</p> <ul style="list-style-type: none"> <li>▶ This icon appears when you press the orange modifier key, indicating it is set to the function mode. Then, press a second key to get the desired function (F5~F8, Tab, Del).</li> <li>▶ The icon will go off automatically.</li> </ul> |

### Blue Modifier Key



This key is a modifier key that requires pressing a second key to get the blue-coded letter (A~Z) or symbol printed on the right side of the second key.

| Icon     | Description  |
|----------|--|
| <b>A</b> | This icon appears when you press the blue key once, indicating it is set to alphabetic mode for typing upper-case alphabetic letters.  |
| <b>a</b> | This icon appears when you press the blue key twice, indicating it is set to alphabetic mode for typing lower-case alphabetic letters. |

### Power Key



In order to prevent an accidental press of the POWER key, you need to hold down this key for approximately 1.5 seconds to turn ON/OFF the mobile computer.

Note: (1) Functionality of keys is application-dependent. The system will send the associated key code to the application program, and it is up to the application program to interpret the key code.

(2) When a status icon appears on the screen, it indicates a certain mode is activated and it is not necessary to hold down the modifier key.

### 1.3.2 39-KEY LAYOUT

The layout of the 39-key keypad includes numeric, navigation and function keys, as well as assorted characters and two modifier keys.

Refer to [Appendix III – Key Reference Tables](#) for color-coded keys.





Figure 4: 39-key Layout





This alphanumeric keypad is set to numeric mode by default. The blue modifier key  serves as a toggle among numeric, alpha (lower-case alphabetic), and ALPHA (upper-case alphabetic) input modes.

**Note:** It is not necessary to hold down the blue modifier key.

The alpha icon will appear on the lower-left corner of the screen in a sequence as shown below.

| Status Icon | Alpha Key   | Input Mode            |
|-------------|---|-----------------------|
| (none)      | N/A   | Numbers               |
| <b>A</b>    | Press  one time  | Upper-case alphabetic |
| <b>a</b>    | Press  two times | Lower-case alphabetic |

The orange modifier key  works with a key on which orange-coded function or symbol is printed on the right side. Press the orange key, and its associated icon  will be displayed on the screen. Press the second key, say F1, to complete the key combination and access the function F11. The icon  will go off automatically.

Blue-coded alphabetic letter  
printed above the upper-right corner

Orange-coded function or symbol  
printed to the right side



Below briefly describes the functions of common keys on the mobile computer.

### SCAN



This yellow key is used to trigger the scan engine so that it can read a barcode when the reader function is enabled.

### ENTER



This key is on the right side of the **SCAN** key. Normally, it is used for command execution or input confirmation.

### ESC (Escape)



This key is on the left side of the **SCAN** key. Normally, it is used to stop and exit the current operation.

### Navigation Keys



These keys are used to move the cursor left, up, down, or right.



- ▶ While pressing , they can be used to adjust the luminosity and contrast of the screen backlight.

### BkSp (Backspace)



















This key is **Backspace** by default. If this key is being held down for more than one second, a `clear` code will be sent.

- ▶ While pressing the key along with the orange modifier key , it becomes the **Delete** key.

### Backlight Configuration Key



This key is used to turn ON/OFF the backlight of the LCD and keypad. Also, while pressing , the navigation keys can be used to adjust the luminosity and contrast of the screen backlight.

| Key   | Description   |
|---|---|
|   | Press these keys at the same time to increase the contrast.   |
|   | Press these keys at the same time to decrease the contrast.   |
|   | Press these keys at the same time to increase the luminosity.   |
|   | Press these keys at the same time to decrease the luminosity.   |
|   | Same as   |
|   | Same as   |

### Orange Modifier Key



This key is a modifier key that requires pressing a second key to get the orange-coded function (F11~F20, Tab, Del) or symbol printed to the right side of the second key.

| Icon | Description  |
|------|--|
|      | <p>By default, the function toggle is set to Auto Resume mode, and its behavior is as described below:</p> <ul style="list-style-type: none"> <li>▶ This icon appears when you press the orange modifier key, indicating it is set to the function mode. Then, press a second key to get the desired function (F11~F20, Tab, Del) or symbol.</li> <li>▶ The icon will go off automatically.</li> </ul> |

### Blue Modifier Key



This key is a modifier key that requires pressing a second key to get the blue-coded letter (A~Z) printed above the upper-right corner of the second key.

| Icon | Description  |
|------|--|
|      | This icon appears when you press the blue key once, indicating it is set to alphabetic mode for typing upper-case alphabetic letters.  |
|      | This icon appears when you press the blue key twice, indicating it is set to alphabetic mode for typing lower-case alphabetic letters. |

### Power Key



In order to prevent an accidental press of the POWER key, you need to hold down this key for approximately 1.5 seconds to turn ON/OFF the mobile computer.

Note: (1) Functionality of keys is application-dependent. The system will send the associated key code to the application program, and it is up to the application program to interpret the key code.

(2) When a status icon appears on the screen, it indicates a certain mode is activated and it is not necessary to hold down the modifier key.

## 1.4 LCD

The mobile computer comes with a FSTN graphic LCD, 160 by 160 pixels resolutions, which can be programmed to display text or graphics, such as specific font and company logo, to meet varying application needs.















| Options                               | Font Size (pixels)       | Characters by lines       |
|---------------------------------------|--------------------------|---------------------------|
| English font                          | Font size 6×8 (pixels)   | 26 characters by 18 lines |
|                                       | Font size 8×16 (pixels)  | 20 characters by 9 lines  |
| Chinese font                          | Font size 12×12 (pixels) | 13 characters by 12 lines |
|                                       | Font size 16×16 (pixels) | 10 characters by 9 lines  |
| Other language fonts, company logo... | Programmable             |                           |

Note: The bottom line (ICON\_ZONE) is reserved to display status icons, such as the battery icon.

### 1.4.1 ADJUSTING THE BACKLIGHT

The backlight of screen and keypad helps ease reading under dim environments. It can be turned on and adjusted decreasingly or increasingly by the following key combinations. Keep pressing the key combination until the luminosity or contrast is decreased or increased to a desired level. Alternatively, the luminosity and contrast can be configured through programming or via **System Menu**. Refer to [3.2.2 Backlight](#) and [3.2.3 Contrast](#).

Note: Using backlight while on battery power will substantially reduce battery power. We suggest that you dim the backlight while working in a well-lit area or have it set to be automatically turned off when not in use.

| Key Combination   |   | Action  |
|---|---|---|
| <b>29-key</b>   | <b>39-key</b>   |   |
|  |  | Toggle ON/OFF the backlight   |
|  |  | Turn ON the backlight and increase the luminosity of LCD                                    |
|  |  | Turn ON the backlight and decrease the luminosity of LCD                                    |
|  |  | Turn ON the backlight and increase the contrast of LCD                                      |
|  |  | Turn ON the backlight and decrease the contrast of LCD                                      |
|   |  | Same as  |
|   |  | Same as  |

Note: Hold down the first key, and keep pressing the second key for adjustment.

## 1.5 NOTIFICATIONS

### 1.5.1 STATUS LED

There are two dual-color LED indicators above the screen. Both can be programmed to provide information that helps diagnosing. For example, if you are using AG runtime, you will be informed of the scanning result immediately. LED1 is used for "Good Read" and will become solid green upon reading a barcode successfully.

- ▶ LED1 is used to provide information on the charging status and barcode decoding.
- ▶ LED2 is used to provide information on wireless communications.

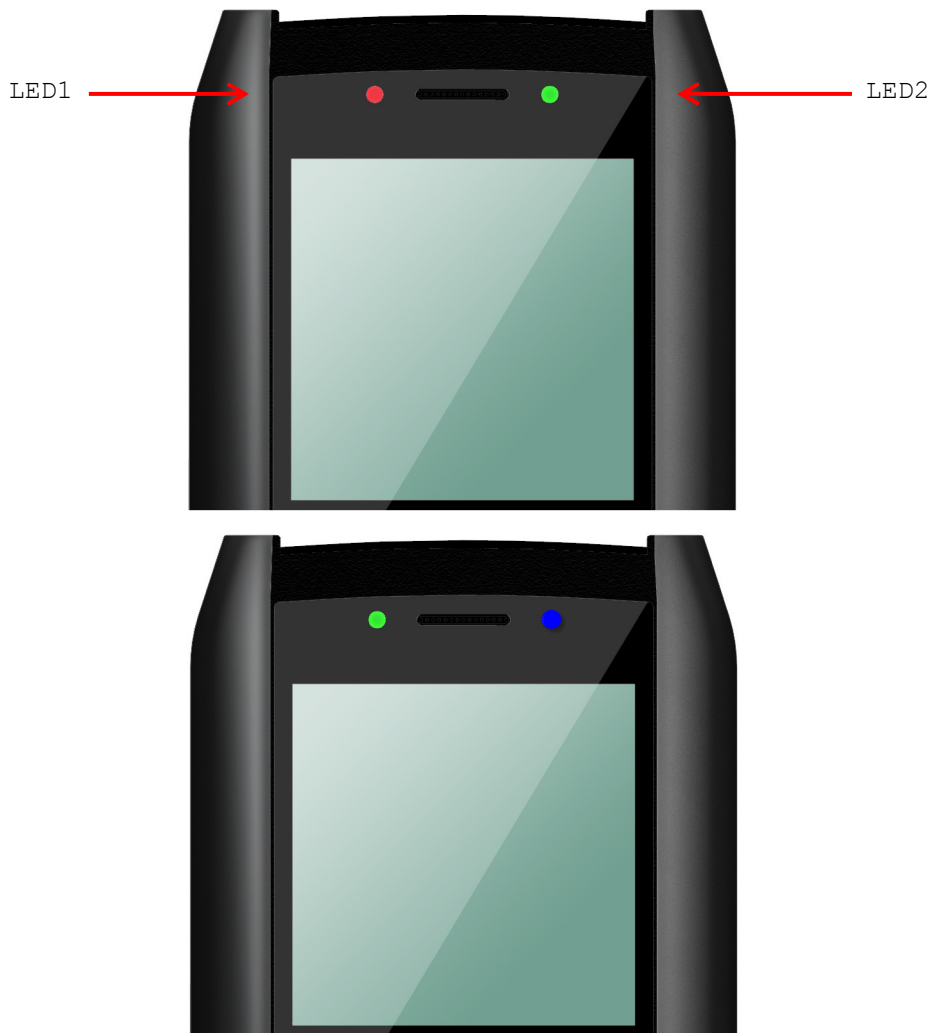

Figure 5: LED Indicators

| LED1: Red/Green             | Red  | Green  |
|-----------------------------|--|--|
| User Power ON               | User definable   | User definable<br>▶ Solid green for Good Read by default   |
| Power Off, Battery Charging | System default<br>▶ Flashing red: Charging   | System default<br>▶ Flashing green: Charging done  |
| Charging Error              | System default<br>▶ Flashing red and green: Charging error occurs  |  |
| LED2: Blue/Green            | Blue   | Green  |
| Bluetooth                   | System default<br>▶ Flashing blue, quickly: Waiting for connection or connecting<br>▶ Flashing blue, slowly: Connected | ---  |
| Wi-Fi                       | ---  | System default<br>▶ Flashing green, quickly: Waiting for connection or connecting<br>▶ Flashing green, slowly: Connected |

## 1.5.2 AUDIO

The mobile computer has a low power transducer type buzzer, which can be programmed for status feedback. Its volume can be configured through programming or via **System Menu**. Refer to [3.2.7 Buzzer Volume](#). In particular, its frequency and duration are software programmable for Good Read in the provided terminal emulation programs.

## 1.5.3 VIBRATOR

The mobile computer is integrated with a vibrator, which can be programmed for status feedback. It can be helpful when working in noisy environments. In particular, the vibrator is software programmable for Good Read in the provided terminal emulation programs.

## 1.6 DATA CAPTURE

A wide variety of scan engines is available for delivering flexibility to meet different requirements. Depending on the scan engine integrated, the mobile computer is capable of scanning barcodes of a number of symbologies that are enabled by default while running the preloaded AG runtime. Refer to [3.3.1 Reader](#) for functional test.

If you need to scan barcodes that are encoded in a symbology, which is disabled by default in AG runtime, **FORGE Application Generator** (ForgeAG.exe) allows configuring symbology settings, as well as reader settings. First, enable the desired symbologies, and then, download the application settings to the mobile computer.

Note: For details on configuring reader and symbology settings, please refer to the documentation of the software you use.

Varying by the scan engine installed, the supported symbologies are listed below.

- ▶ 1D CCD scan engine
- ▶ 1D Laser scan engine
- ▶ 2D scan engine

Note: In AG or CipherNet runtime, not all of the symbologies are enabled by default. Instead of running any of them, you can develop your own applications to control the scan engine for data collection.

| Symbologies Supported (Default Setting: Enable/Disable) |                             | CCD/Laser | 2D       |
|---|-----------------------------|-----------|----------|
| <b>Codabar</b>  |                             | Enabled   | Enabled  |
| <b>Code 11</b>  |                             |           | Enabled  |
| <b>Code 93</b>  |                             | Enabled   | Enabled  |
| <b>Composite Code</b>                                   | CC-A/B                      |           | Disabled |
|   | CC-C                        |           | Disabled |
|   | TCIF Linked Code 39         |           | Enabled  |
| <b>MSI</b>  |                             | Disabled  | Enabled  |
| <b>Plessey</b>  |                             | Disabled  |          |
| <b>Postal Codes</b>                                     |                             |           | Enabled  |
| <b>Telepen</b>  |                             | Disabled  |          |
| <b>Code 128</b>   | Code 128                    | Enabled   | Enabled  |
|   | GS1-128 (EAN-128)           | Enabled   | Enabled  |
|   | ISBT 128                    | Enabled   | Enabled  |
| <b>Code 2 of 5</b>                                      | Industrial 25 (Discrete 25) | Enabled   | Enabled  |
|   | Interleaved 25              | Enabled   | Enabled  |
|   | Matrix 25                   | Disabled  | Disabled |

|                          |                                      |          |          |
|--------------------------|--------------------------------------|----------|----------|
|                          | Chinese 25                           |          | Disabled |
|                          | Coop 25                              | Disabled |          |
| <b>Code 3 of 9</b>       | Code 39                              | Enabled  | Enabled  |
|                          | Trioptic Code 39                     |          | Disabled |
|                          | Italian Pharmacode (Code 32)         | Disabled | Disabled |
|                          | French Pharmacode                    | Disabled |          |
| <b>EAN/UPC</b>           | EAN-8                                | Enabled  | Enabled  |
|                          | EAN-8 Addon 2                        | Disabled | Disabled |
|                          | EAN-8 Addon 5                        | Disabled | Disabled |
|                          | EAN-13                               | Enabled  | Enabled  |
|                          | EAN-13 & UPC-A Addon 2               | Disabled | Disabled |
|                          | EAN-13 & UPC-A Addon 5               | Disabled | Disabled |
|                          | Bookland EAN (ISBN)                  | Disabled | Disabled |
|                          | UPC-E0                               | Enabled  | Enabled  |
|                          | UPC-E1                               | Disabled | Disabled |
|                          | UPC-E Addon 2                        | Disabled | Disabled |
|                          | UPC-E Addon 5                        | Disabled | Disabled |
|                          | UPC-A                                | Enabled  | Enabled  |
| <b>GS1 DataBar (RSS)</b> | GS1 DataBar Omnidirectional (RSS-14) | Disabled | Enabled  |
|                          | GS1 DataBar Truncated                | Disabled | Enabled  |
|                          | GS1 DataBar Stacked                  | Disabled | Enabled  |
|                          | GS1 DataBar Stacked Omnidirectional  | Disabled | Enabled  |
|                          | GS1 DataBar Limited (RSS Limited)    | Disabled | Enabled  |
|                          | GS1 DataBar Expanded (RSS Expanded)  | Disabled | Enabled  |
|                          | GS1 DataBar Expanded Stacked         | Disabled | Enabled  |
| <b>2D Symbologies</b>    | PDF417                               |          | Enabled  |
|                          | MicroPDF417                          |          | Enabled  |
|                          | Data Matrix                          |          | Enabled  |
|                          | Maxicode                             |          | Enabled  |
|                          | QR Code                              |          | Enabled  |



## 1.7 CHARGING & COMMUNICATIONS

Normally, the mobile computer ships with a USB or RS-232 cable for charging and communications. A variety of cradles are available to meet different requirements.

### USB Interface Cable

| Task           | USB Cable  |
|----------------|--|
| Charging       | USB direct charging <ul style="list-style-type: none"> <li>▶ 500 mA: USB icon</li> <li>▶ 100 mA: Highlighted USB icon</li> </ul> 5 V charging from the adaptor (Plug icon)   |
| Communications | USB Virtual COM — If using FORGE Application Generator software, you may use a download utility to receive data on your computer; otherwise, run HyperTerminal.exe to receive data directly.<br><br>USB HID — Run a text editor on your computer to receive data directly. |

Note: (1) If you are using USB Virtual COM for the first time, you must install its driver from the CD-ROM. Driver version 5.3 or later is required. Please remove older versions! The virtual COM port will not be assigned until the USB port is in use. (2) For Standard USB cable, it will release COM port in the following conditions: (i) detach the cable from the mobile computer directly, (ii) detach the cable from the cradle directly, (iii) when the cable is attached to the cradle, take away the mobile computer, (iv) the mobile computer is turned off, (v) no application is running on the mobile computer, or COM port is shut down. For applications that require COM port to be occupied all the time, it is suggested to use 308 USB Virtual COM Interface cable instead.

### RS-232 Interface Cable

| Task           | RS-232 Cable   |
|----------------|--|
| Charging       | 5 V charging from the adaptor (Plug icon)  |
| Communications | If using FORGE Application Generator software, you may use a download utility to receive data on your computer; otherwise, run HyperTerminal.exe to receive data directly. |

### Cradle

| Task           | Cradle Interface  |
|----------------|---|
| Charging       | 5 V charging from the adaptor (Plug icon)   |
| Communications | Depends on the cradle type and its associated settings — <ul style="list-style-type: none"> <li>▶ USB</li> <li>▶ RS-232</li> <li>▶ Modem</li> <li>▶ Ethernet</li> <li>▶ GPRS/GSM</li> </ul> |

Note: Battery charging stops when the temperature drops below 0°C or exceeds 40°C. It is recommended to charge the battery at room temperature (18°C to 25°C) for optimal performance.

### 1.7.1 INTERFACE CABLE OPTIONS

For charging via the USB cable, the standard charging current is 500 mA. However, we recommend you to connect the power adaptor to speed up charging the battery.

- ▶ If you connect the mobile computer to a USB hub, the charging current may be insufficient. In that case, change the charging current to 100 mA after connecting the USB cable. It will take a longer time to charge to full. Refer to [3.2.9 USB Charge Current](#).

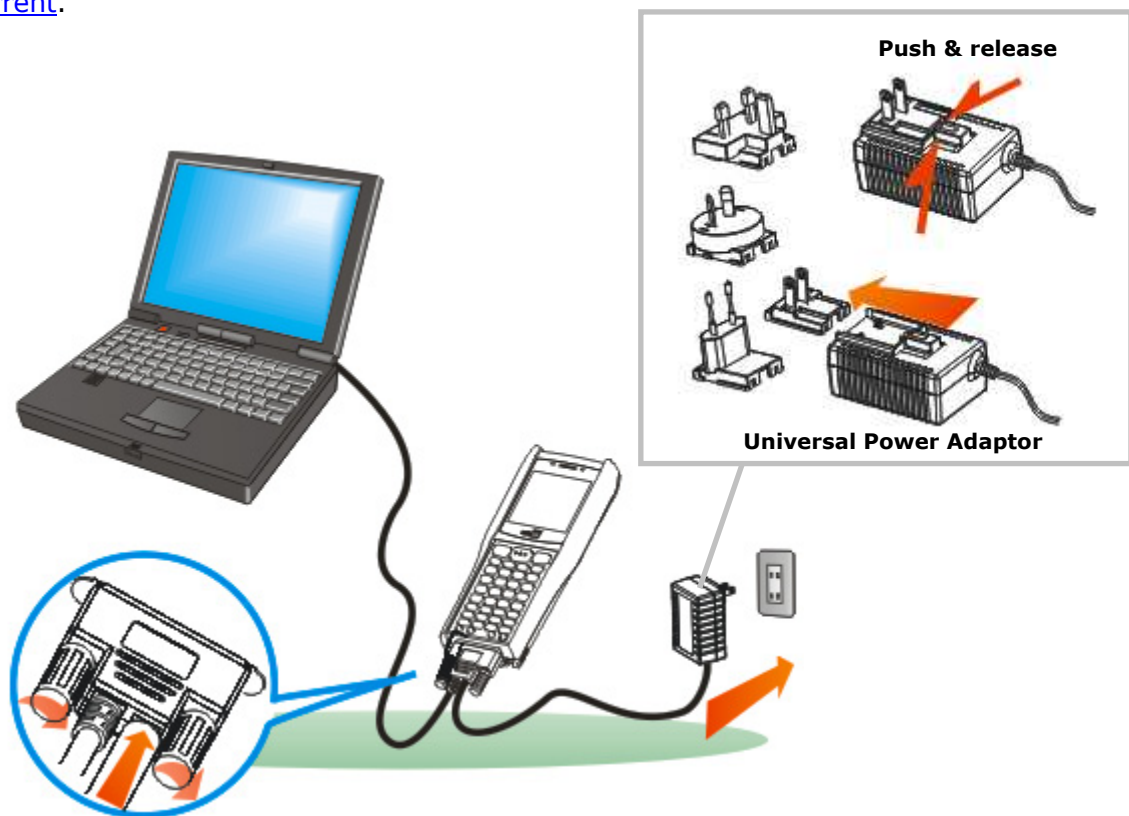

Figure 6: Using USB/RS-232 cable

Warning: The mobile computer is not allowed to function when it is solely on USB power and without a battery loaded. It will display a warning message "Battery Missing" along with an audible alert. In that case, you should install the battery before restarting.

## 1.7.2 CRADLE OPTIONS

The cradle is designed for charging and communications at the same time. You may choose a cradle type that best suits your needs.

- 1) Seat the mobile computer in the cradle.
- 2) Connect the power supply cord to the power receptacle on the cradle (A) or join it to the cable connector if the charging & communication cable is present (B).
- 3) Connect the other end of the power cord to a suitable power outlet.
- 4) Connect the charging & communication cable if data transmission is required.

Refer to the separate manual for configuring the Ethernet Cradle or GPRS/GSM Cradle (EDGE/Quad-band).

Note: Tighten the two screw-in connectors to secure the cable.

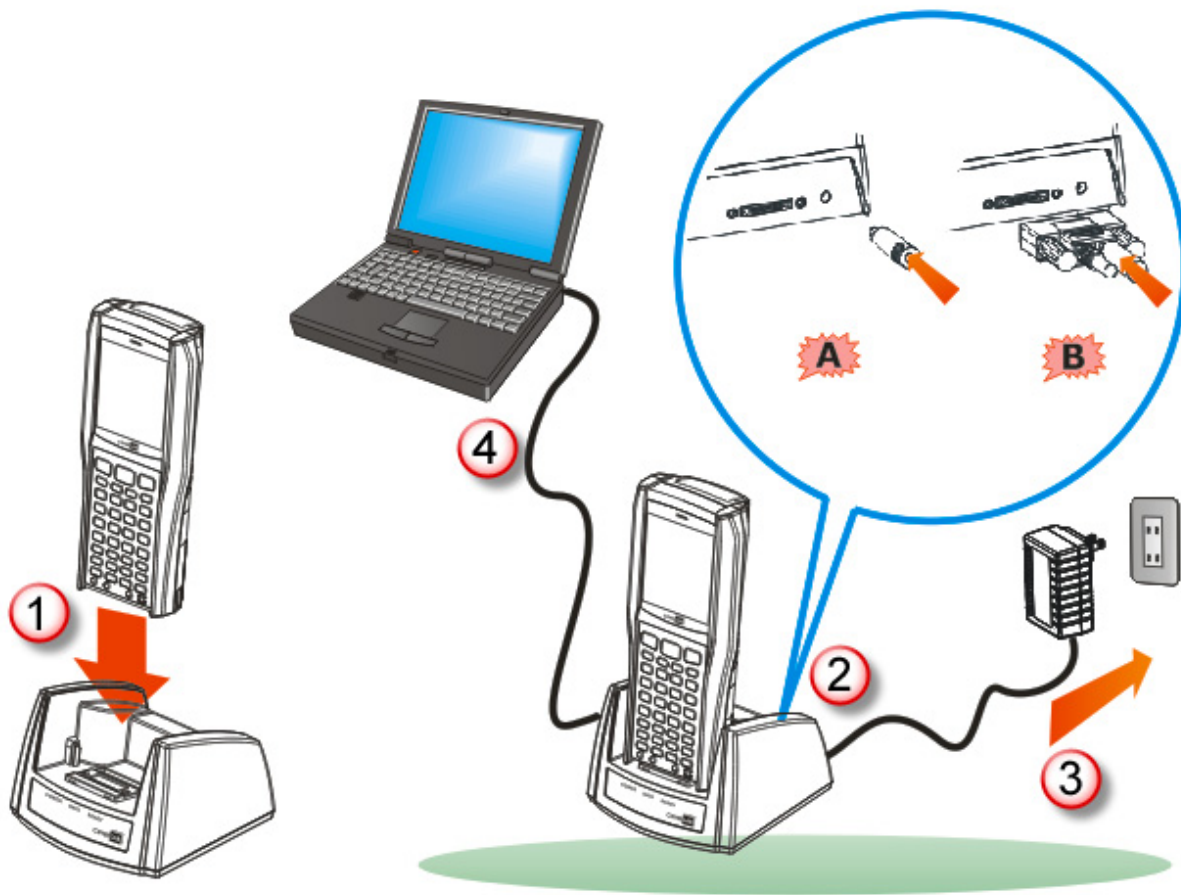
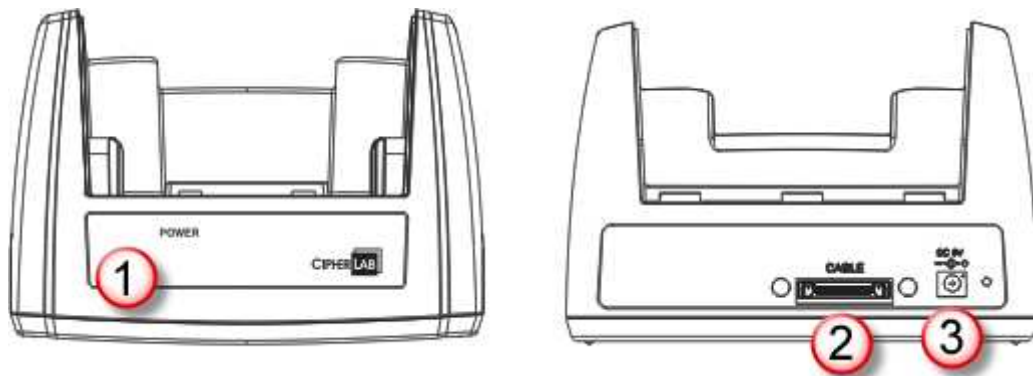

Figure 7: Setting up cradle

### Charging & Communication Cradle

---



| No. | Description           | No. | Description                     |
|-----|-----------------------|-----|---------------------------------|
| 1   | LED Indicator (POWER) | 2   | Cable Connector (USB or RS-232) |
| 3   | Power Jack            |     |                                 |

### Modem Cradle

---

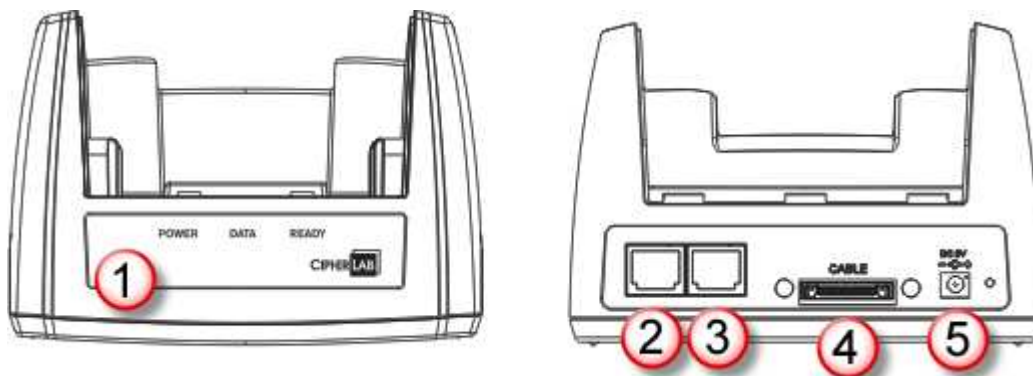

| No. | Description                         | No. | Description                     |
|-----|-------------------------------------|-----|---------------------------------|
| 1   | LED Indicators (POWER, DATA, READY) | 2   | Line/Phone Jack                 |
| 3   | Line/Phone Jack                     | 4   | Cable Connector (USB or RS-232) |
| 5   | Power Jack                          |     |                                 |

**Ethernet Cradle**

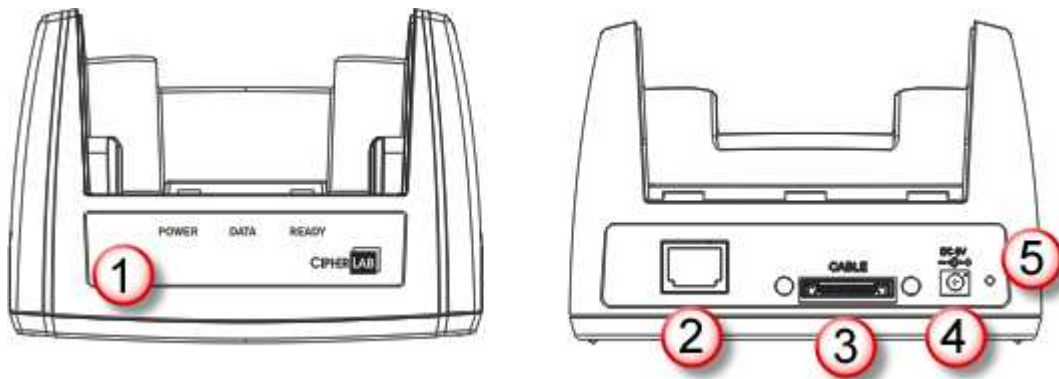

| No. | Description                         | No. | Description           |
|-----|-------------------------------------|-----|-----------------------|
| 1   | LED Indicators (POWER, DATA, READY) | 2   | Ethernet Port (RJ-45) |
| 3   | Cable Connector (USB or RS-232)     | 4   | Power Jack            |
| 5   | IP Reset Switch                     |     |                       |

**GPRS/GSM Cradle (EDGE/Quad-band)**

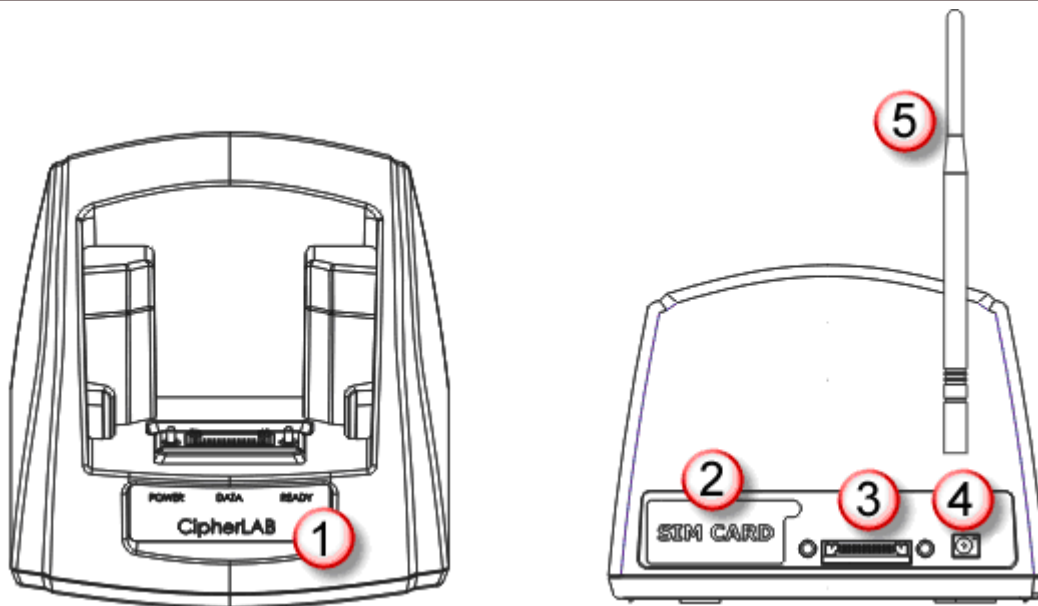

| No. | Description                         | No. | Description   |
|-----|-------------------------------------|-----|---------------|
| 1   | LED Indicators (POWER, DATA, READY) | 2   | SIM Card Slot |
| 3   | Cable Connector (USB or RS-232)     | 4   | Power Jack    |
| 5   | Antenna                             |     |               |

### 1.7.3 4-SLOT BATTERY CHARGER

Below is the 4-Slot Battery Charger.

- 1) The Battery Charger can be mounted on table or wall. Drill two holes (centers spaced 105 millimeters apart), secure the two supplied screws, and mount the Battery Charger by sliding over screws.
- 2) Seat batteries with contacts facing to back.
- 3) Connect the power supply cord to the power receptacle on the charger. Connect the other end of the power supply cord to a suitable power outlet.
- 4) Press the power switch on, and the Battery Charger's LED will be blue.
- 5) While charging, the LED of the battery compartment will be red. When fully charged, the LED will be green.

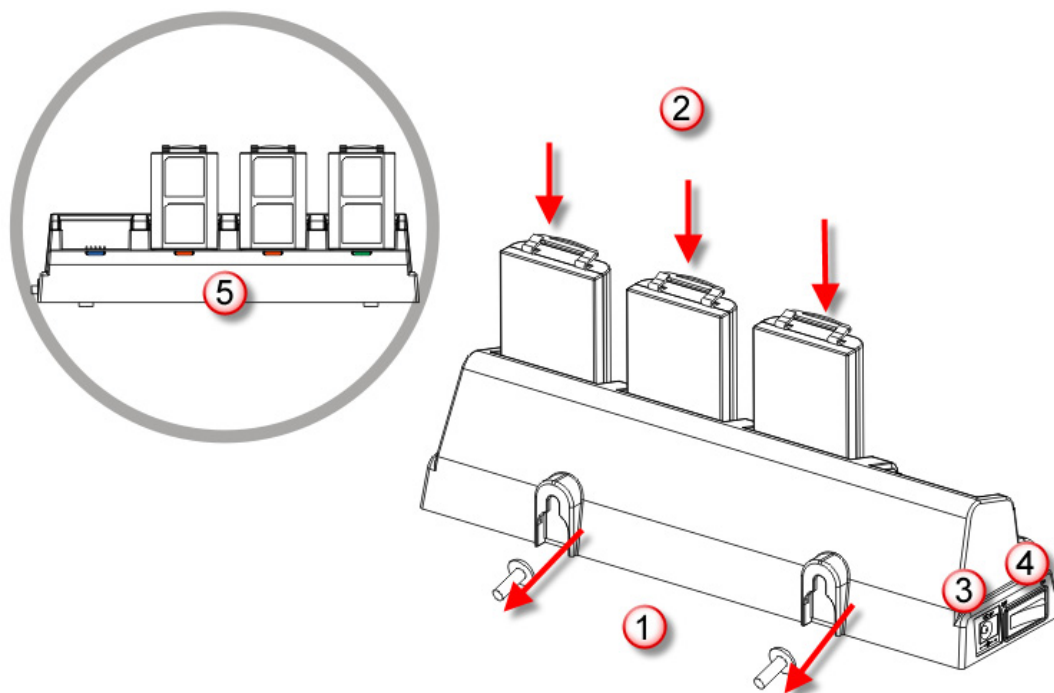

Figure 8: 4-Slot Battery Charger

| Indicator                       | Status       | Description   |
|---------------------------------|--------------|---------------|
| <b>POWER / Battery Charging</b> | Off          | Power off     |
|                                 | Blue, solid  | Power on      |
|                                 | Red, solid   | Charging      |
|                                 | Green, solid | Charging done |

## 1.8 SD CARD

SD card can be accessed directly by using the provided functions in user application. Yet, when 8400 is equipped with SD card and connected to your computer via the USB cable, it can be treated as a removable disk (USB mass storage device) as long as it is configured properly through programming or via **System Menu | 8. Next Page | 1. SD Card Menu | 1. Run As USB Disk**. Refer to [3.8 SD Card Menu](#).

Note: (1) DAT files created on SD card by previous BASIC runtime are not compatible in file format with new BASIC runtime, starting from version 1.10.  
 (2) While running BASIC application, the size of DAT files on SD card can be calibrated. Go to **System Menu | 8. Next Page | 1. SD Card Menu | 2. Access SD Card | 4. Check File Size** to refresh the size of "A:\BASICRUN\TXACTn.DAT" (n=1~6).

### 1.8.1 FILE SYSTEM

For 8400 Series, it supports FAT12/FAT16/FAT32 and allows formatting the card through C programming or via **System Menu | 8. Next Page | 1. SD Card Menu | 2. Access SD Card**. Based on the capacity of the card, it will automatically decide the FAT format:

| Card Capacity | FAT Format | Sectors per Cluster |
|---------------|------------|---------------------|
| ≤ 32 MB       | FAT12      | 32                  |
| ≤ 1 GB        | FAT16      | 32                  |
| ≤ 2 GB        | FAT16      | 64                  |
| ≤ 8 GB        | FAT32      | 8                   |

### 1.8.2 DIRECTORY

Unlike the file system on SRAM, the file system on SD card supports hierarchical tree directory structure and allows creating sub-directories. Several directories are reserved for particular use.

| Reserved Directory | Related Application or Function   | Remark  |
|--------------------|---|---|
| \Program           | <ul style="list-style-type: none"> <li>▶ System Menu   Load Program</li> <li>▶ Program Manager   Download</li> <li>▶ Program Manager   Activate</li> <li>▶ Kernel Menu   Load Program</li> <li>▶ Kernel Menu   Kernel Update</li> <li>▶ UPDATE_BASIC()</li> </ul> | Store programs to this folder so that you can download them to 8400: <ul style="list-style-type: none"> <li>▶ C program — *.SHX</li> <li>▶ BASIC program — *.INI and *.SYN</li> </ul> |
| \BasicRun          | BASIC Runtime   | Store DAT and DBF files that are created and accessed in BASIC runtime to this folder.<br>Their permanent filenames are as follows:   |

|  |              |                      |        |
|--|--------------|----------------------|--------|
|  |              | DAT Filename         |        |
|  | DAT file # 1 | TXACT1.DAT           |        |
|  | DAT file # 2 | TXACT2.DAT           |        |
|  | DAT file # 3 | TXACT3.DAT           |        |
|  | DAT file # 4 | TXACT4.DAT           |        |
|  | DAT file # 5 | TXACT5.DAT           |        |
|  | DAT file # 6 | TXACT6.DAT           |        |
|  |              | DBF Filename         |        |
|  | DBF file # 1 | Record file          | F1.DB0 |
|  |              | System Default Index | F1.DB1 |
|  |              | Index file # 1       | F1.DB2 |
|  |              | Index file # 2       | F1.DB3 |
|  |              | Index file # 3       | F1.DB4 |
|  | DBF file # 2 | Record file          | F2.DB0 |
|  |              | System Default Index | F2.DB1 |
|  |              | Index file # 1       | F2.DB2 |
|  |              | Index file # 2       | F2.DB3 |
|  |              | Index file # 3       | F2.DB4 |
|  | DBF file # 3 | Record file          | F3.DB0 |
|  |              | System Default Index | F3.DB1 |
|  |              | Index file # 1       | F3.DB2 |
|  |              | Index file # 2       | F3.DB3 |
|  |              | Index file # 3       | F3.DB4 |
|  | DBF file # 4 | Record file          | F4.DB0 |
|  |              | System Default Index | F4.DB1 |
|  |              | Index file # 1       | F4.DB2 |
|  |              | Index file # 2       | F4.DB3 |
|  |              | Index file # 3       | F4.DB4 |
|  | DBF file # 5 | Record file          | F5.DB0 |
|  |              | System Default Index | F5.DB1 |
|  |              | Index file # 1       | F5.DB2 |
|  |              | Index file # 2       | F5.DB3 |
|  |              | Index file # 3       | F5.DB4 |



|            |                                   |  |
|------------|-----------------------------------|--|
| \AG\DBF    | Application Generator (a.k.a. AG) | Store DAT, DBF, and Lookup files that are created and/or accessed in Application Generator to this folder. |
| \AG\DAT    |                                   |  |
| \AG\EXPORT |                                   |  |
| \AG\IMPORT |                                   |  |

### 1.8.3 FILE NAME

A file name must follow 8.3 format (= short filenames) — at most 8 characters for filename, and at most three characters for filename extension. The following characters are unacceptable: " \* + , : ; < = > ? | [ ]

- ▶ On 8400 Series, it can only display a filename of 1 ~ 8 characters (the null character not included), and filename extension will be displayed if provided. If a file name specified is longer than eight characters, it will be truncated to eight characters.
- ▶ Long filenames, at most 255 characters, are allowed when using 8400 equipped with SD card as a mass storage device. For example, you may have a filename "123456789.txt" created from your computer. However, when the same file is directly accessed on 8400, the filename will be truncated to "123456~1.txt".
- ▶ If a file name is specified other in ASCII characters, in order for 8400 to display it correctly, you may need to download a matching font file to 8400 first.
- ▶ The file name is not case-sensitive.





## LEARNING SOFTWARE ARCHITECTURE

---

This chapter mainly describes the software inside the mobile computer. It consists of three modules — Kernel, System, and Application; each has a function menu.



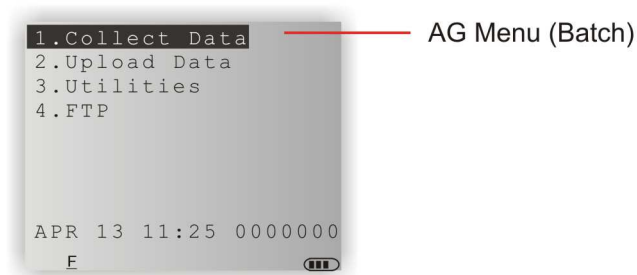
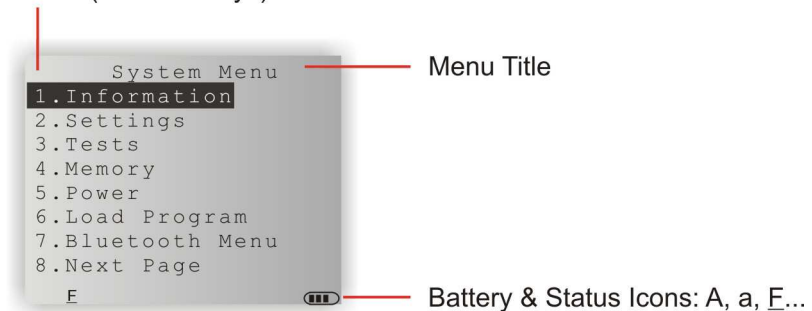

When a menu is displayed, you may select an item by either of the following ways:

- ▶ Press the arrow keys  (Up)  (Down) to move the highlight bar.
- ▶ Press the number key that corresponds to the item number.
- ▶ Follow the on-screen instructions to change a specific setting, or press [ESC] to return to a previous page or menu.

Item No. (Shortcut keys)



On each screen, the bottom line displays status icons, such as:

- ▶ The 4-bar battery icon indicates the current power status.
- ▶ The status icon of input mode is controlled by the blue modifier key:  or .
- ▶ The status icon of function mode is controlled by the orange modifier key:  or .

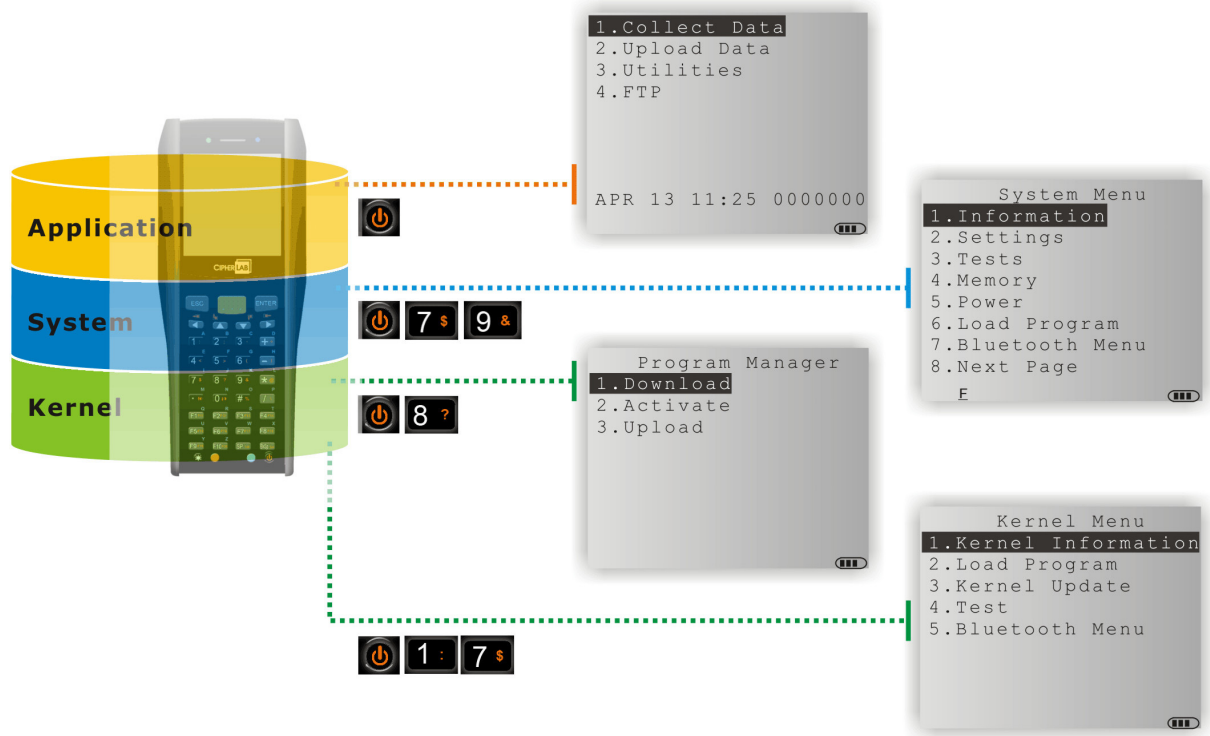

Figure 9: Software Architecture

**IN THIS CHAPTER**

2.1 Application Module ..... 35  
 2.2 System Configuration & Core ..... 37

## 2.1 APPLICATION MODULE

The mobile computer ships with software package on the CD-ROM. It includes **FORGE Application Generator** (batch and WLAN versions), **MIRROR Emulator** (VT and 5250 versions), download utilities, etc.

### 2.1.1 FORGE APPLICATION GENERATOR (AG)

For easy development of applications, the mobile computer is preloaded with AG runtime. When you turn on the mobile computer, it displays the Main Menu of AG application, as shown below.

Batch AG

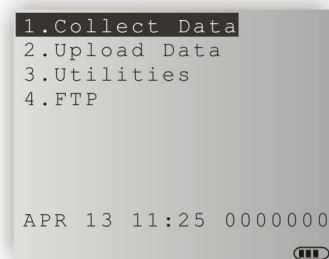

WLAN AG

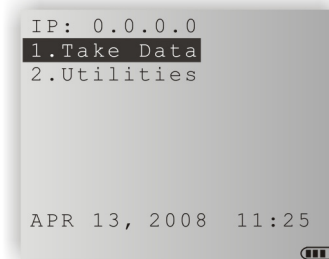

**Note:** Batch AG supports automatically uploading data to a host computer when the upload interface is properly configured. Once the mobile computer is connected via the RS-232 or USB Virtual COM cable, there will be a moving hourglass icon displayed on the upper-right corner of the screen, indicating the mobile computer is ready for auto upload.

Before using the mobile computer to collect data, you need to configure the application with the companion tool on your computer. This time-saving development tool helps create application templates on your computer.

For details on the AG application, please refer to separate user manual.

| Application Generator | AG Runtime | Companion Tool on PC End |
|-----------------------|------------|--------------------------|
| <b>Batch AG</b>       | U8400.SHX  | ForgeAG.exe              |
| <b>WLAN AG</b>        | WU8400.SHX | AG8400WLAN.exe           |

**Note:** FORGE Application Generator (AG) software package includes  
 (1) a companion tool for quickly developing your application — Batch or WLAN AG;  
 (2) several download utilities to make it versatile in use.

### 2.1.2 MIRROR EMULATOR (CIPHERNET)

The mobile computer supports VT100/220 and IBM 5250 terminal emulation for accessing a backend database. Instead of using **FORGE Application Generator**, you may download the terminal emulation program, i.e. CipherNet Runtime, to the mobile computer. Refer to 3.6 [Load Program](#). Then, run individual companion tool on your computer.

For details on the **MIRROR Emulator** application, please refer to separate user manuals.

| Terminal Emulation | CipherNet Runtime | Companion Tool on PC End |
|--------------------|-------------------|--------------------------|
| <b>VT100/220</b>   | 84xx-VT.SHX       | CipherNet-VT.exe         |
| <b>IBM 5250</b>    | 84xx-5250.SHX     | CipherNet-5250.exe       |

### 2.1.3 USER PROGRAM

You may need to develop your own application program. For developing custom applications, CipherLab provides BASIC and C compilers through licensing. For detailed information, please contact your sales representative.

## 2.2 SYSTEM CONFIGURATION & CORE

For managing system configurations and multiple programs, each mobile computer comes with **System Menu**, **Kernel**, and **Program Manager**. Refer to the following chapters on how to configure the 8400 Series Mobile Computer, regarding system configurations and program download.

### 2.2.1 SYSTEM MENU

[System Menu](#) is bundled with BASIC Runtime or user programs that are written in "C". It is provided for system configuration, functionality testing, downloading font file and program.

### 2.2.2 KERNEL

[Kernel](#) is the innermost core of the OS. It provides services for downloading the active application program or font file, updating the kernel and configuring Bluetooth settings.

### 2.2.3 PROGRAM MANAGER

[Program Manager](#) is part of the kernel. You may download as many as eight application programs, or seven programs plus one font file.





## SYSTEM MENU

---

**System Menu** is generated by a powerful utility, which offers an interface for engineers (programmers or system integrator) to view system information, change the configuration parameters, download programs and run diagnostics.

This menu is designed for engineering tests and maintenance ONLY. For this reason, it provides password protection to prevent unauthorized users from accidentally changing system settings.

---

**Warning!** System Menu is NOT for the use of any end users. The system password helps ensure system safety and integrity.

---

### How to access System Menu?

---

- 1) Turn off the mobile computer.
- 2) Press [7] + [9] + [Power].



## IN THIS CHAPTER

|                                |    |
|--------------------------------|----|
| 3.1 Information.....           | 40 |
| 3.2 Settings .....             | 42 |
| 3.3 Tests .....                | 46 |
| 3.4 Memory.....                | 48 |
| 3.5 Power .....                | 49 |
| 3.6 Load Program.....          | 50 |
| 3.7 Bluetooth Menu .....       | 53 |
| 3.8 SD Card Menu .....         | 62 |
| 3.9 Ethernet Cradle Menu ..... | 64 |
| 3.10 Serial PPP Menu .....     | 67 |
| 3.11 Wi-Fi Menu.....           | 70 |

## 3.1 INFORMATION

Here provides important system information to help diagnose the system.

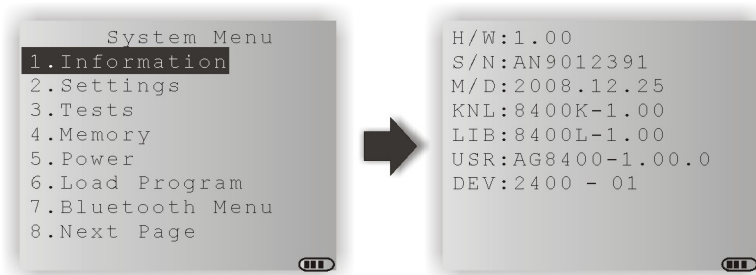

### System Menu | 1. Information

|            |  |
|------------|--|
| <b>H/W</b> | Hardware version   |
| <b>S/N</b> | A serial number assigned to the mobile computer  |
| <b>M/D</b> | Manufacturing date   |
| <b>KNL</b> | Kernel version   |
| <b>LIB</b> | C library version  |
| <b>BSC</b> | BASIC Run-time version, if a BASIC application is downloaded   |
| <b>USR</b> | Application program version  |
| <b>DEV</b> | 6-digit code for optional hardware configurations <ul style="list-style-type: none"> <li>▶ For example, 2400-01 indicates the 39-key mobile computer is equipped with Laser scan engine and 802.11b/g connectivity.</li> </ul> |

## 3.1.1 UNDERSTANDING DEVICE CODE

| Device Code | Modular Component | Types  |
|-------------|-------------------|--|
| 1st digit   | Reader module     | 0= none<br>1= CCD scan engine<br>2= Laser scan engine<br>3= 2D scan engine |
| 2nd digit   | Wireless module   | 4= Bluetooth + 802.11b/g (8470)<br>5= Bluetooth only (8400)                |
| 3rd digit   | Reserved          | 0  |
| 4th digit   | Reserved          | 0  |
| 5th digit   | Keypad module     | Keypad hardware version  |
| 6th digit   | Keypad Layout     | 0= 29-key<br>1= 39-key   |

## 3.2 SETTINGS

You can change the default settings here.

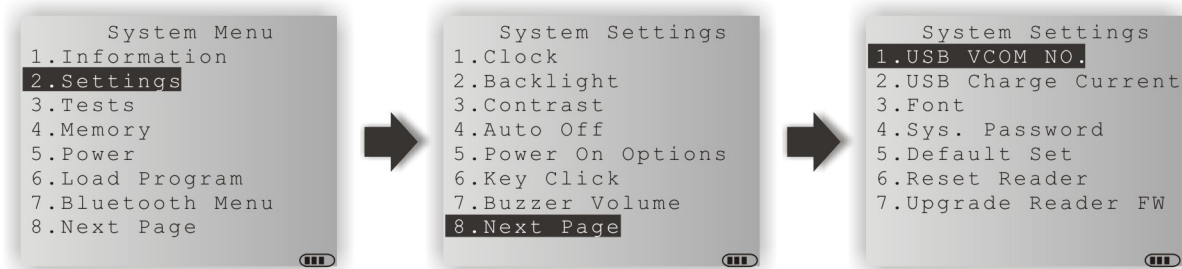



| System Settings           | Default Values  |
|---------------------------|---|
| <b>Clock</b>              | Current time  |
| <b>Backlight</b>          | 20 seconds at level 2, backlight shade enabled        |
| <b>Contrast</b>           | Level 4   |
| <b>Auto Off</b>           | 10 minutes  |
| <b>Power On Options</b>   | Program Resume  |
| <b>Key Click</b>          | Tone 2  |
| <b>Buzzer Volume</b>      | High volume level                                     |
| <b>USB VCOM No.</b>       | Fixed   |
| <b>USB Charge Current</b> | 500 mA  |
| <b>System Password</b>    | Open access   |
| <b>Font</b>               | System font   |
| <b>Reset to Default</b>   | Load factory settings                                 |
| <b>Reset Reader</b>       | Restore default reader settings                       |
| <b>Upgrade Reader FW</b>  | Upgrade 2D reader firmware (For maintenance use only) |

### 3.2.1 CLOCK

Set date and time for Real Time Clock. Enter two digits for the year, e.g. 04 for 2004.

### 3.2.2 BACKLIGHT

Set the backlight duration for the keypad and LCD.

- ▶ Enter a value between 0 and 9999 (second).
- ▶ Press the arrow keys  (Up)  (Down) to adjust the backlight level (4 levels).
- ▶ Press the  (Left) key to adjust the shade effect.

### 3.2.3 CONTRAST

Set the contrast level for the LCD.

- ▶ Press the arrow keys  (Up)  (Down) to adjust the contrast level.

### 3.2.4 AUTO OFF



The mobile computer will be turned off automatically when no operation is taking place during a specified period of time. Enter a value between 0 and 999 (minute).

Note: To disable this function, enter 0.

### 3.2.5 POWER ON (& WAKEUP EVENT) OPTIONS



Set the startup screen once the mobile computer is turned on, and specify which events will wake up the mobile computer:

#### Power On Options

Press the arrow keys  (Up)  (Down) to select "Program Resume" or "Program Restart", and then press [ENTER].

- ▶ Program Resume: When selected, the mobile computer will start from the last session of program before it is turned off.
- ▶ Program Restart: When selected, the mobile computer will start from the first session of the program.

#### WakeUp Events

The specified events can wake up the mobile computer when the conditions are met. Press the arrow keys  (Up)  (Down) to select a specific event, and press [ENTER] to determine when it is treated as a wake-up event or not.

- ▶ PwrKey: If yes, it will wake up the mobile computer upon pressing the Power key.
- ▶ RS232: If yes, it will wake up the mobile computer upon connecting the RS-232 cable.
- ▶ RS232\_RXD: If yes, it will wake up the mobile computer upon receiving a specific signal via the RS-232 cable.
- ▶ USB: If yes, it will wake up the mobile computer upon connecting the USB cable.
- ▶ Charging: If yes, it will wake up the mobile computer upon getting charged via the cradle or direct charging.
- ▶ Charged: If yes, it will wake up the mobile computer upon completion of charging.
- ▶ Alarm: If yes, it will wake up the mobile computer upon the alarm time is up. Alarm can be set up through programming only.

### 3.2.6 KEY CLICK

The system will produce an audible signal when any key on the keypad is pressed. The current value is highlighted. Select a desired tone for the buzzer or mute it.

### 3.2.7 BUZZER VOLUME

Set the buzzer volume.

- ▶ Press the arrow keys  (Up)  (Down) to adjust the volume level (3 levels).

### 3.2.8 USB VCOM NO

By default, it is set to use one virtual COM port for all (=FIXED), regardless of how many 8400 mobile computers are connected to PC when USB Virtual COM is in use. This setting requires you to connect one 8400 at a time, and will facilitate configuring a great amount of 8400 mobile computers via the same virtual COM port (for administrators' or factory use). If necessary, you can have it set to use variable virtual COM port (=Change by Serial Number), which will vary by the serial number of each different 8400.

- ▶ Press the arrow keys  (Up)  (Down) to select between "Fixed" and "Change by Serial Number".

### 3.2.9 USB CHARGE CURRENT

By default, the USB charging current is set to 500 mA. For direct charging via the USB cable without supplying a power adaptor, the standard charging current is 500 mA. If you connect the mobile computer to a USB hub, the charging current may be insufficient. In that case, change the charging current to 100 mA after connecting the USB cable. It will take a longer time to charge to full.

- ▶ Press the arrow keys  (Up)  (Down) to select between "500 mA" and "100 mA".

---

Note: (1) USB direct charging, 500 mA: USB icon  
(2) USB direct charging, 100 mA: Highlighted USB icon  
(3) 5V charging from the adaptor: Plug icon

---

### 3.2.10 FONT

Font version information can be viewed here. It displays System Font if there is no custom font file. If a multi-language font file is downloaded, you will be able to select a font from the list.

### 3.2.11 SYSTEM PASSWORD

Set a password to control user access to **System Menu**, **Program Manager** and **Kernel Menu**. The password can be up to eight alphanumeric characters.

---

Note: The password is case-sensitive. To disable a previous password, enter blank on the "Input new password" and "Verify password" screens.

---

### 3.2.12 RESET TO DEFAULT

Reset system settings to the default values, except for the reader settings.

### 3.2.13 RESET READER

Reset reader settings to the default values.

### 3.2.14 UPGRADE READER FW

Upgrade 2D reader firmware if necessary.

## 3.3 TESTS

Here provides functional tests for key parts.

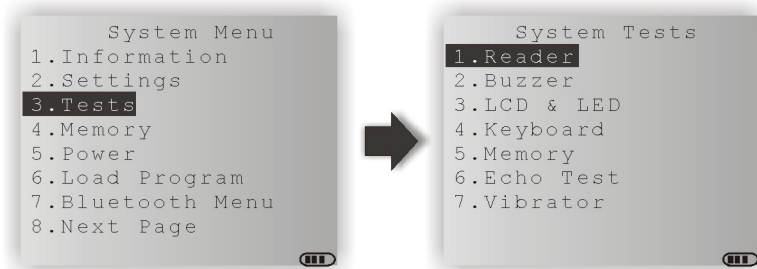

### 3.3.1 READER

Test the reading performance of the scanner. The supported symbologies depend on the scan engine you use. Refer to [1.6 Data Capture](#) for symbologies that are enabled by default. For symbologies that are disabled by default, they must be enabled through programming.

- ▶ Press [SCAN] to start. To stop and exit the test, press any key.

### 3.3.2 BUZZER

Test the buzzer with different frequency/duration combinations.

- ▶ To stop and exit the test, press any key.

### 3.3.3 LCD & LED

Test the LCD display and LED indicators.

- ▶ To stop and exit the test, press any key.

### 3.3.4 KEYBOARD

Test the rubber keys. Press any key and its corresponding character will be shown on the screen.

- ▶ To stop and exit the test, press [ESC].

### 3.3.5 MEMORY

Test the data memory (SRAM), and the results will be shown on the screen.

- ▶ To stop and exit the test, press [ESC].

---

**Warning!** The contents of the data memory (SRAM) will be wiped out after test.

---



### 3.3.6 ECHO TEST

After a physical connection is established properly, run a test utility on your computer and start the test on your mobile computer. Select a desired baud rate if necessary.

- ▶ To stop and exit the test, press [ESC].

| Interface | Description  | Test Utility   |
|-----------|--|--|
| RS-232    | This echo test is to verify connectivity via the RS-232 cable between the mobile computer and a host computer.   | EchoTest.exe   |
| Modem     | This echo test is to verify connectivity via the Modem Cradle. A telephone line must be connected to the Modem Cradle.   | EchoTest.exe   |
| USB       | <p>This echo test is to verify connectivity via the USB cable between the mobile computer and a host computer.</p> <ul style="list-style-type: none"> <li>▶ USB VCOM Echo — The mobile computer works as a generic USB device.</li> <li>▶ USB HID — The mobile computer works as an input device; select keyboard type and Caps Lock status for running a test.</li> </ul> | <p>EchoTest.exe for Virtual COM</p> <p>Any text editor for HID</p> |

### 3.3.7 VIBRATOR

Test the vibrator.

- ▶ To stop and exit the test, press [ESC].

## 3.4 MEMORY

Here provides information and initialization function of the memory.

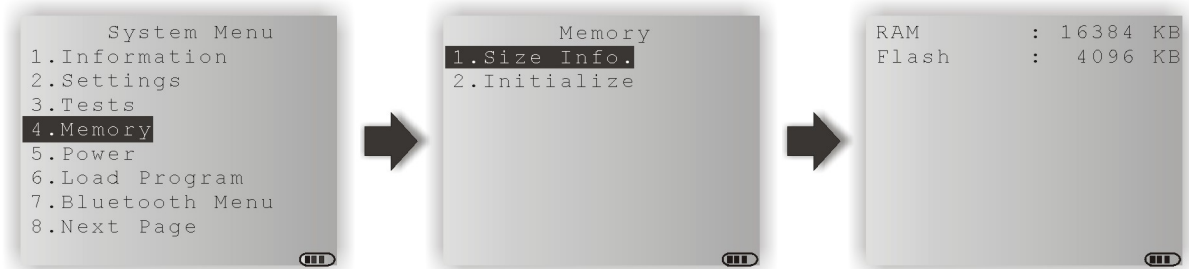

### 3.4.1 SIZE INFORMATION

- ▶ RAM — onboard SRAM for data memory
- ▶ Flash — program memory

### 3.4.2 INITIALIZE

Initialize the data memory.

---

**Warning!** The contents of the data memory (SRAM) will be wiped out after memory initialization.

---

## 3.5 POWER

Here shows current voltage consumption.

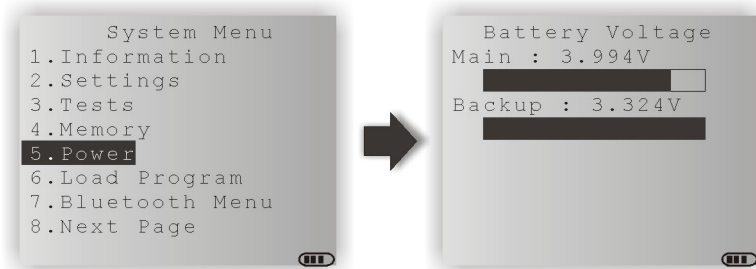

### Main (battery)

It shows dynamic status of the battery pack, which is used as the main power source.

### Backup (battery)

It shows dynamic status of the button cell, which is used to retain data in SRAM.

**Warning!** Always examine the battery icon on the device screen so that you will be alerted for a low battery condition.

### 3.6 LOAD PROGRAM

Here you can access the [Load Program](#) service provided by the kernel. Because the kernel will take over the job, you will not be able to return to **System Menu** by pressing [ESC]. After downloading, restart the mobile computer to activate the new program. Refer to [Appendix I Download Utility](#).

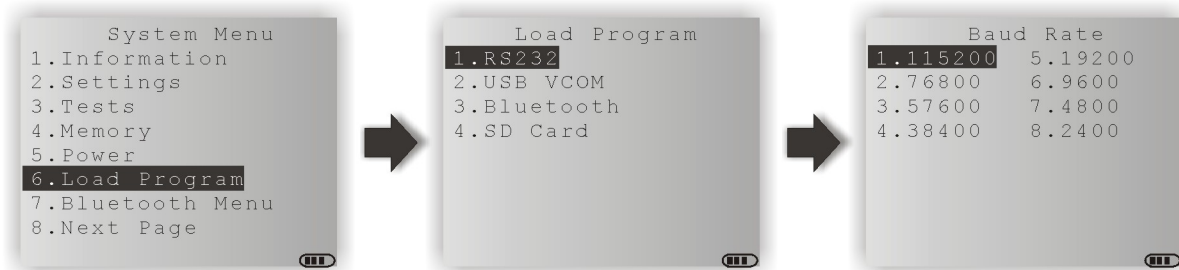

**Note:** The mobile computer will stay in download mode for approximately 30 seconds.

#### .SHX Program

Download one of the following C program files and/or font file:

##### Program File

- ▶ AG Runtime: U8400.shx (Batch AG)  
WU8400.shx (WLAN AG)
- ▶ CipherNet Runtime: 84xx-5250.shx (CipherNet-5250)  
84xx-VT.shx (CipherNet-VT)
- ▶ BASIC Runtime<sup>Note</sup>: B8400.shx
- ▶ User program

##### Font File

Refer to the Font Files folder on CD-ROM.

If you have downloaded a BASIC Runtime program, the next time you enter the Load Program submenu you will be able to select whether to download a C program (.SHX) or BASIC program (.SYN).

**Note:** "Load Basic" menu is only available after you have downloaded a BASIC Runtime program.

## SETTINGS

### Interface

| Options   | Description   |
|-----------|---|
| RS232     | Proceed to configure baud rate settings on your computer and the mobile computer. |
| USB VCOM  | Connect the USB cable between your computer and the mobile computer.              |
| Bluetooth | Approach the target Bluetooth enabled device.                                     |
| SD Card   | This option is available only when the memory card is present.                    |



### Baud Rate

| Options      | Supported by CipherLab software, including download utilities |    |
|--------------|---|----|
| 115200 (bps) | Yes   |    |
| 76800 (bps)  |   | No |
| 57600 (bps)  | Yes   |    |
| 38400 (bps)  | Yes   |    |
| 19200 (bps)  | Yes   |    |
| 9600 (bps)   | Yes   |    |
| 4800 (bps)   |   | No |
| 2400 (bps)   |   | No |

## LOAD PROGRAM VIA BLUETOOTH

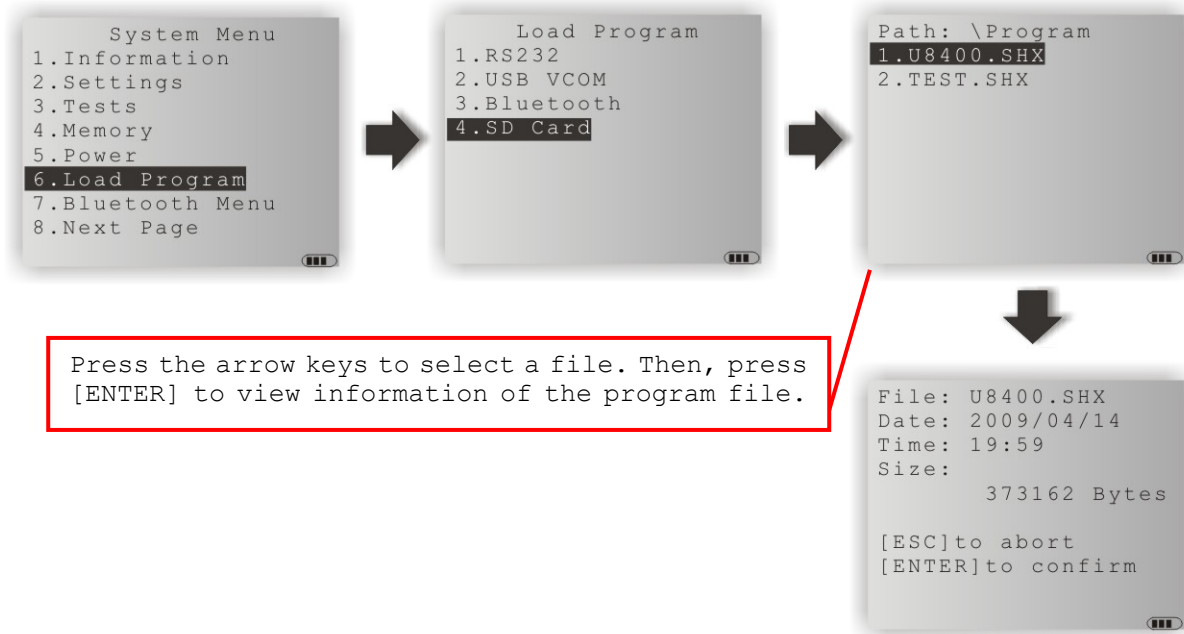
- 1) Go to **System Menu | 7. Bluetooth Menu | 3. Security**, and configure the following Bluetooth settings first.
  - ▶ Authentication
  - ▶ PIN code
- 2) Go to **System Menu | 6. Load Program** and select Bluetooth.
- 3) Start the pairing procedure from your computer, for example, click [Pair Device] and/or [Connect Bluetooth Serial Port].
- 4) Run the download utility: ProgLoad.exe
  - Select interface RS-232 for using Bluetooth SPP.
  - Select COM port properties that match with the serial port settings used on your computer.

**LOAD PROGRAM VIA SD CARD**

- 1) If you have copied the desired program file(s) to your SD card, go to **System Menu | 6. Load Program** and select SD Card. You will see a list of all the files under the directory "\Program", as shown above.
- 2) Press the arrow keys   to select a file.
- 3) Press [ENTER] to view information of the program file.
- 4) Press [ENTER] to confirm downloading the program file to the mobile computer.  
Press [ESC] to abort the download task.

### 3.7 BLUETOOTH MENU

This submenu is for the mobile computer, with built-in Bluetooth module, to work with other Bluetooth enabled devices. You must configure these parameters correctly.

| Bluetooth Settings     | Default Value          | HID                             | SPP | DUN                 |
|------------------------|------------------------|---------------------------------|-----|---------------------|
| <b>Connect Setting</b> |                        | <b>Items Need to Be Checked</b> |     |                     |
| Local Name             | Model no. + Serial no. | v                               | v   | v                   |
| Remote Name            | ---                    | ---                             | v   | v                   |
| Broadcast Me           | Enable                 | v                               | v   | v                   |
| Power Saving           | Enable                 | v                               | v   | v                   |
| BT-GPRS AP Name        | ---                    | ---                             | --- | (v) <sup>Note</sup> |
| DHCP                   | Enable                 | ---                             | --- | (v) <sup>Note</sup> |
| Local IP Address       | 0.0.0.0                | ---                             | --- | (v) <sup>Note</sup> |
| <b>Security</b>        |                        |                                 |     |                     |
| Authentication         | Disable                | v                               | v   | v                   |
| PIN Code               | ---                    | v                               | v   | v                   |

Note: BT-GPRS AP Name, DHCP and local IP Address are available only when you download a user program to the mobile computer for DUN-GPRS mode. That is, an external library, 84PPP.lib or 84WLAN.lib, is included in your program (.SHX).

### 3.7.1 INFORMATION

Information of network configuration can be viewed here.

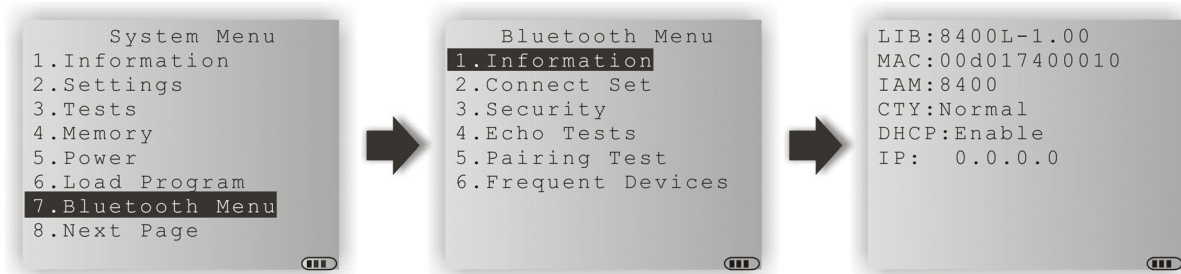

#### Bluetooth Menu | 1. Information

|             |   |
|-------------|---|
| <b>LIB</b>  | C library version   |
| <b>MAC</b>  | MAC address of the Bluetooth module   |
| <b>IAM</b>  | A name given to the mobile computer for identification. <ul style="list-style-type: none"> <li>▶ By default, it is made up of model number and the serial number. (Identical to 2. Connect Set   1. Local Name)</li> </ul>  |
| <b>CTY</b>  | "Normal" means all 79 channels are available for frequency-hopping <ul style="list-style-type: none"> <li>▶ There are bandwidth limitations for 2.4 GHz ISM band in some countries. For example, only 23 RF channels are defined instead of 79 RF channels in Japan, Spain and France.</li> </ul> |
| <b>DHCP</b> | DHCP server in use or not <ul style="list-style-type: none"> <li>▶ It will automatically become enabled while connecting to a BT-GPRS AP.</li> </ul>  |
| <b>IP</b>   | IP address of the mobile computer   |

Note: Information on DHCP and IP is available only when you download a user program to the mobile computer for DUN-GPRS mode.



### 3.7.2 CONNECT SETTING

Set the connection parameters if necessary.

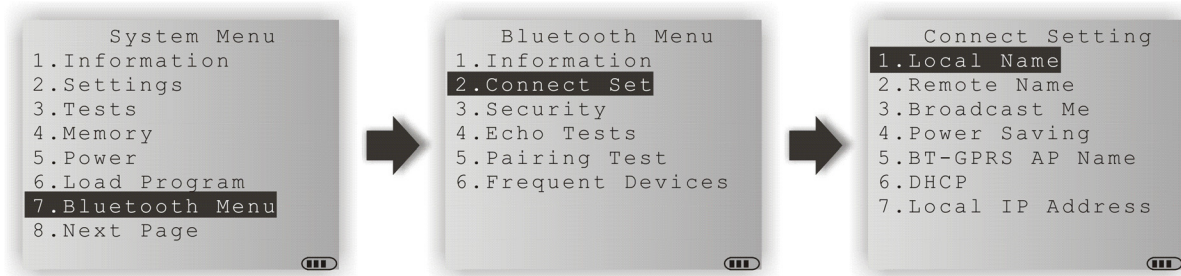

#### Local Name

Enter a name for identifying the mobile computer.

- ▶ By default, it is made up of model number and the serial number.

#### Remote Name

Enter a name for making a specific connection.

- ▶ The remote name must be one of those in the Frequent Devices list. Otherwise, the mobile computer will fail to make a connection with any device without pairing.
- ▶ DO NOT specify any remote name when roaming across different groups of APs is required.

#### Broadcast Me

Options — Enable or Disable

- ▶ For initial connection, broadcasting must be enabled so that other Bluetooth devices can discover the mobile computer.
- ▶ For security concerns, you may disable it in future use to hide the mobile computer from other Bluetooth devices.

#### Power Saving

This refers to the low power consumption mode.

Options — Enable or Disable (Only the Sniff mode is supported.)

#### BT-GPRS AP Name

For DUN-GPRS mode, enter the AP name for connecting to the content server.

#### DHCP

Options - Enable or Disable

#### Local IP Address

Enter a new address for the mobile computer, if necessary.

Note: BT-GPRS AP Name, DHCP and local IP Address are available only when you download a user program to the mobile computer for DUN-GPRS mode.

### 3.7.3 SECURITY

Set or modify security parameters.

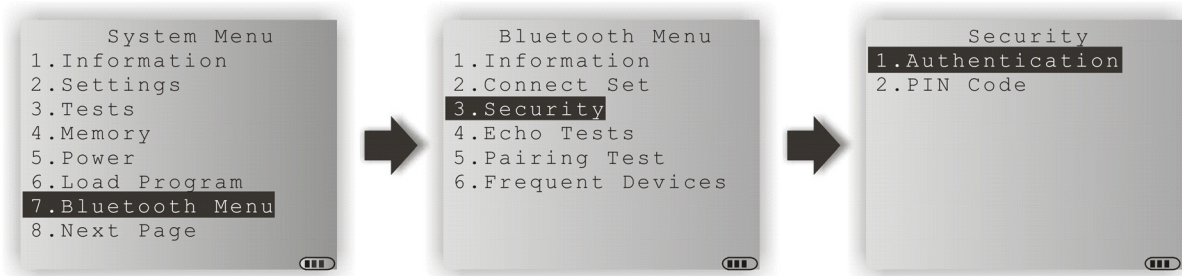

---

#### Authentication

Options — Enable or Disable

---

#### PIN Code

Define the encryption key values.

- ▶ Up to 16 characters, using ASCII code.

---

**Note:** When authentication is enabled without providing a pre-set PIN code, the mobile computer supports dynamic input of PIN code during pairing.

---

### 3.7.4 ECHO TESTS

These echo tests are used for verifying connectivity to make sure the mobile computer is within coverage. Press [ESC] to stop and exit the test.

- ▶ **SPP:** Serial Port Profile  
It is used for ad hoc networking.
- ▶ **DUN:** Dial-Up Networking Profile  
DUN Modem - It makes use of a Bluetooth modem or mobile phone as a wireless modem.  
DUN GPRS - It makes use of a mobile phone with GPRS functionality and connects to GPRS AP.
- ▶ **HID:** Human Interface Device Profile  
It is used for the mobile computer to work as an input device, i.e. keyboard, for a host computer.

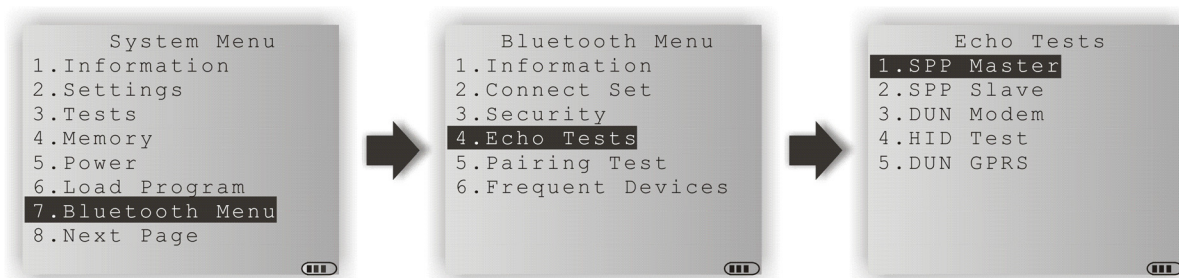

Note: DUN-GPRS is available only when you download a user program to the mobile computer for DUN-GPRS mode.

### SPP Master

---

Set the mobile computer as a master device.

1. Pairing with your computer (slave) must be completed first.
2. Run the utility "EchoTest.exe" on your computer. Associated settings include
  - Select "RS-232" for interface.
  - Use the Bluetooth COM port that has been paired.
  - Set Action Mode to "Passive".
3. Start the echo test on both ends. The mobile computer will try to connect to PC (slave).

### SPP Slave

---

Set the mobile computer as a slave device.

1. Enable Authentication and set your PIN code on the mobile computer.
2. Run the utility "EchoTest.exe" on your computer. Associated settings include
  - Select "RS-232" for interface.
  - Use the Bluetooth COM port that has been configured as "outgoing".
  - Set Action Mode to "Passive".
3. Start the echo test on both ends.
4. The mobile computer will wait for PC (master) to start the connection.
5. Enter the preset PIN code for authentication on your computer.

### DUN Modem

---

The mobile computer will try to connect to a Bluetooth modem or mobile phone.

1. Pairing with your mobile phone must be completed first.  
Select "DialUp Network" for Target Machine options.
2. Run the utility "EchoTest.exe" on your computer. Associated settings include
  - Select "Modem" for interface.
  - Set Action Mode to "Passive".
3. Start the echo test on both ends.
4. The mobile computer will connect to your mobile phone that dials up to your computer.

### HID Test

---

Set the mobile computer as an input device.

1. The mobile computer will wait for PC to start the connection.  
It is suggested to disable Authentication on the mobile computer.
2. Run a text editor on your computer.
3. Start to input data via the keypad on the mobile computer.

### DUN GPRS

---

The mobile computer will try to connect to a mobile phone with GPRS functionality.

1. Pairing with your mobile phone must be completed first.  
Select "DialUp Network" for Target Machine options.
2. Run the utility "EchoTest.exe" on your computer. Associated settings include
  - Select "TCP/IP – Server" for interface.
  - Set Action Mode to "Passive".
3. Start the echo test on both ends.
4. Enter the server IP on the mobile computer.
5. The mobile computer will connect to your mobile phone that dials up a GPRS AP, and finally connect to your computer (server) through the GPRS AP.

### 3.7.5 PAIRING TEST

The pairing procedure is for the creation and exchange of a link key between two Bluetooth-enabled devices. The devices use the link key for future authentication when exchanging information.

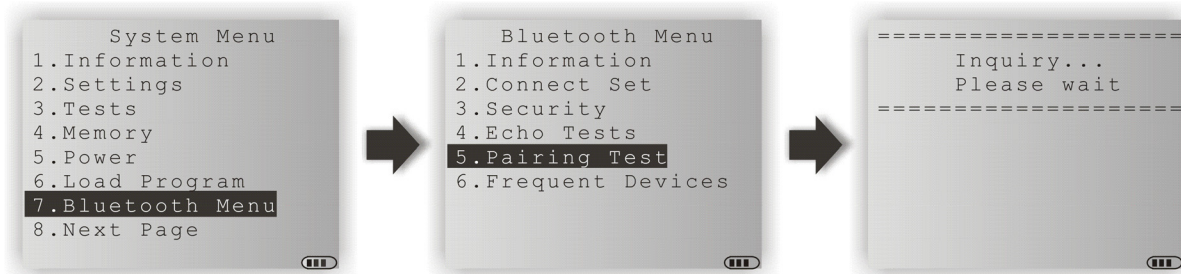

- 1) The mobile computer will start with making an inquiry so that the system can generate a list of device(s) that has been discovered nearby.
- 2) Select a desired target device.  
For the device name, it can only display a maximum length of 11 characters. When the device name is too long, it will be truncated automatically.
- 3) Select a Bluetooth service from the "Target Machine" menu. To stop and exit the test, press [ESC].  
After pairing successfully, the target device will be added to the Frequent Devices List for quick connection in the future.

---

Note: For the initial use of Bluetooth networking, the pairing procedure must be done before the Echo tests.

---

### 3.7.6 FREQUENT DEVICES

Here is a list of devices that the mobile computer has been connected to lately. After each successful pairing, the system will update it.

- ▶ This list can show information of one device that provides Serial Port (SPP), Human Interface Device (HID) or Dial-Up Networking (DUN) service. However, if you access the list via **Kernel Menu**, it can only show information of the target device connected via SPP.
- ▶ For the device name, it can only display a maximum length of 11 characters. When the device name is too long, it will be truncated automatically.

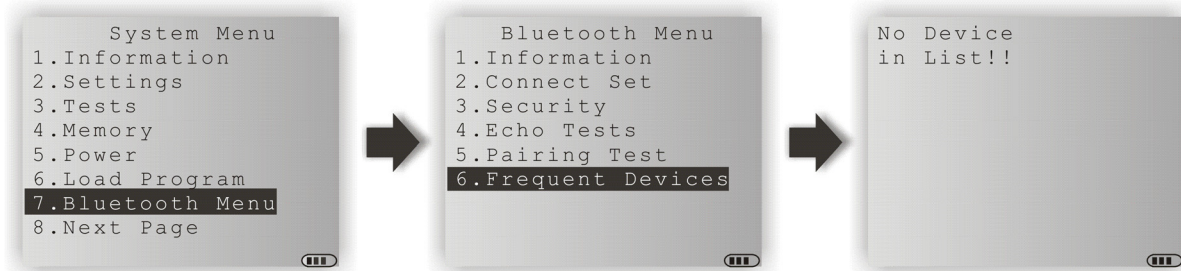

**Note:** To unpair any device, simply delete the device from this list.

### 3.8 SD CARD MENU

This submenu is for using the mobile computer equipped with SD card as a removable disk, as well as for directly accessing files on SD card.

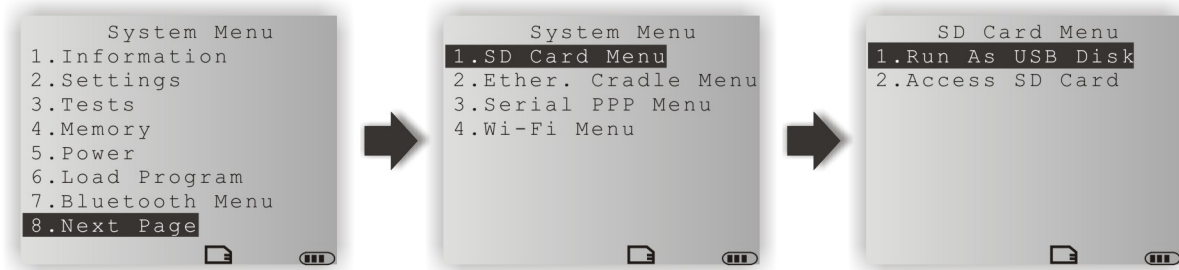

**Note:** When SD card is present, the card icon will appear flashing while being accessed. If the mobile computer is preloaded with Batch AG runtime, it will automatically create two working directories "\AG\IMPORT" and "\AG\EXPORT" on SD card.

#### 3.8.1 RUN AS USB DISK

When the mobile computer is equipped with SD card and connected to your computer via the USB cable, it can be treated as a removable disk (USB mass storage device) as long as it is configured properly through programming or via selecting [Run as USB Disk].

**Note:** (1) The SD card must be properly configured through programming or user menu before use. (2) Depending on the card capacity, it takes about 30 seconds or longer for PC to identify 8400 as a removable disk.

#### 3.8.2 ACCESS SD CARD

Edit the file system or format the SD card.

##### Edit Files

View and edit the file system on SD card.

##### Format

If the file system is not desired any more, you may format the SD card.

- ▶ If the capacity is 32 MB or under, the file system will be FAT12.
- ▶ If the capacity is 32 MB~2 GB, the file system will be FAT16.
- ▶ If the capacity is larger than 2 GB, the file system will be FAT32.

**Warning!** The contents on SD card will be wiped out after formatting.



### **Check Memory**

---

For an SD card that has never been used on 8400, a message like "Found New SD Card" will be displayed allowing users to scan the card for memory check. If the action is canceled then, memory check can still be performed here.

### **Check File Size**

---

You may calibrate the size of DAT files on SD card while running BASIC application, and it will refresh the size of "A:\BASICRUN\TXACTn.DAT" (n=1~6).

---

Note: "Check File Size" is only available after you have downloaded the BASIC Runtime.

---

### 3.9 ETHERNET CRADLE MENU

This submenu is for establishing an Ethernet connection via the Ethernet Cradle. You must configure these parameters correctly.

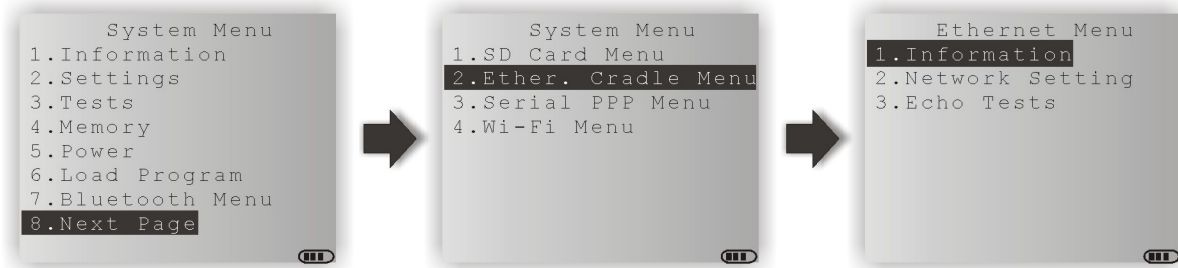

Note: The menu is available only when an external library, 84PPP.lib or 84WLAN.lib, is included in your program (.SHX).

#### 3.9.1 INFORMATION

Information of Ethernet network configuration can be viewed here.

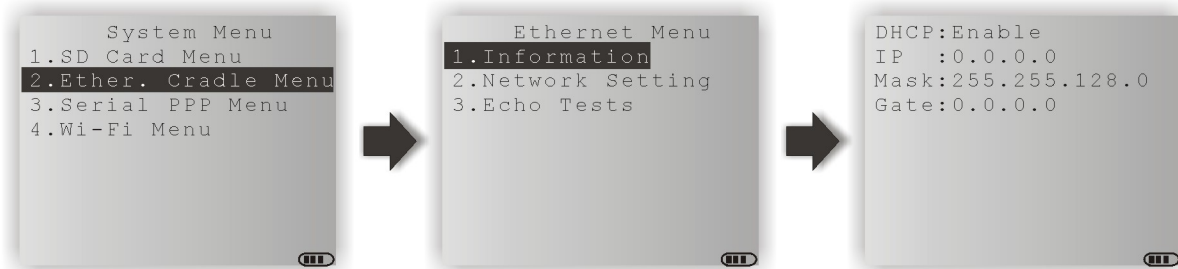

##### IR Network Menu | 1. Information

|             |                                   |
|-------------|-----------------------------------|
| <b>DHCP</b> | DHCP server in use or not         |
| <b>IP</b>   | IP address of the mobile computer |
| <b>Mask</b> | Subnet Mask                       |
| <b>Gate</b> | Default Gateway                   |

### 3.9.2 NETWORK SETTING

Set parameters for IP networking.

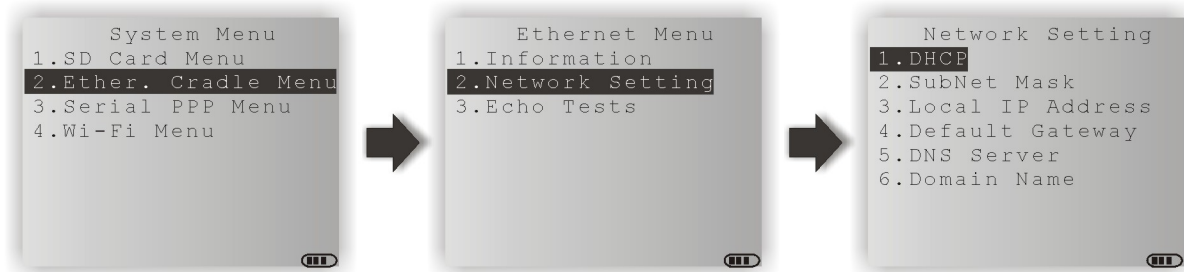

#### DHCP

Options - Enable or Disable

#### Subnet Mask

Enter a new Mask IP, if necessary.

#### Local IP Address

Enter a new address for the mobile computer, if necessary.

#### Default Gateway

Enter a new address for the default Gateway, if necessary.

#### DNS Server

Enter a new address for the DNS server, if necessary.

#### Domain Name

The domain name of the host is displayed when DHCP server is enabled.

**Note:** Normally, DHCP is enabled and all of the settings can be obtained from the DHCP server.

### 3.9.3 ECHO TESTS

The Ethernet Cradle supports three working modes:

- ▶ Data Mode
- ▶ Modem Mode
- ▶ Transparent Mode

These echo tests are used for verifying connectivity via the Ethernet Cradle. For details, refer to the Ethernet Cradle manual.

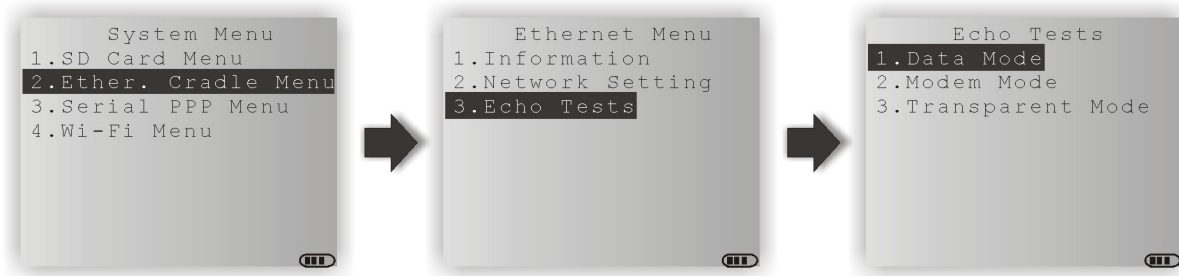

---

#### Data Mode

Set the Ethernet Cradle in Data mode. The mobile computer works as a client.

---

#### Modem Mode

Set the Ethernet Cradle in Modem mode. The mobile computer works as a client.

---

#### Transparent Mode

1. Client Mode - Set the mobile computer as a client.  
Enter the IP address of a server with which a connection is desired.
2. Server Mode - Set the mobile computer as a server that waits for other devices to connect to.

---

Note: After the Ethernet connection is established properly, run the utility "EchoTest.exe" on your computer (TCP/IP - Server or Client), and then, start this test on your mobile computer.

---

### 3.10 SERIAL PPP MENU

This submenu is for establishing a PPP connection via the Modem Cradle. You must configure these parameters correctly.

- ▶ Point-to-Point Protocol (PPP) is a method of connecting the mobile computer to the Internet over serial links. It sends TCP/IP packets to a server that connects to the Internet.

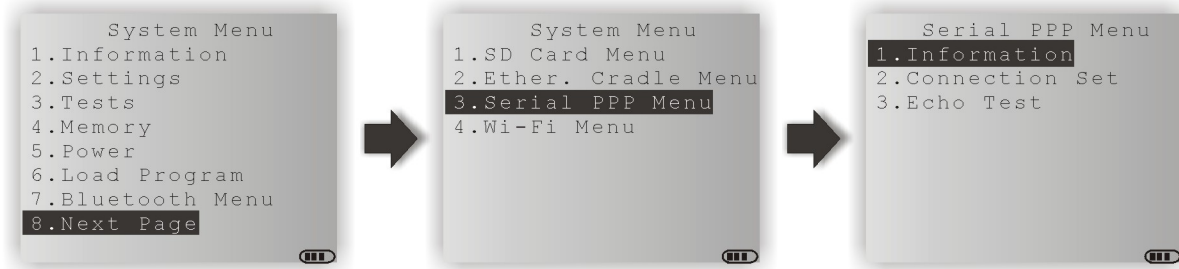

Note: The menu is available only when an external library, 84PPP.lib or 84WLAN.lib, is included in your program (.SHX).

#### 3.10.1 INFORMATION

Information of library version can be viewed here.

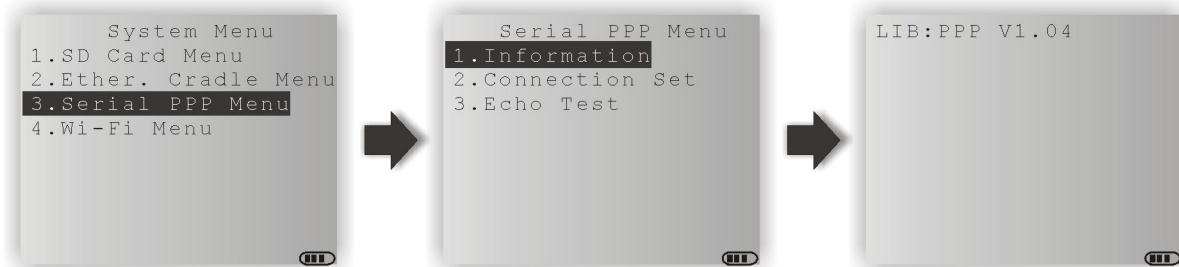

#### Serial PPP Menu | 1. Information

**LIB**            PPP library version

Below are available libraries that support (1) PPP connection over serial links, and (2) Ethernet connection – Transparent mode.

| Series      | Model #                                | External Libraries      |
|-------------|--|-------------------------|
| <b>8400</b> | 8400            (Bluetooth)            | 84PPP.lib               |
|             | 8470            (Bluetooth, 802.11b/g) | 84PPP.lib or 84WLAN.lib |

### 3.10.2 CONNECTION SET

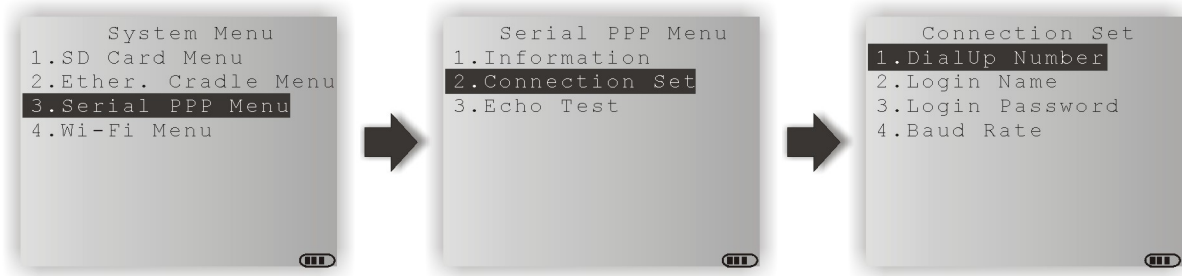

---

#### DialUp Number

Enter the number provided by your ISP.

---

#### Login Name

Enter the login name provided by your ISP.

---

#### Login Password

Enter the login password provided by your ISP.

---

#### Baud Rate

Select a desired baud rate.

### 3.10.3 ECHO TEST

This echo test is used for verifying connectivity via Point-to-Point Protocol.

- ▶ Select "via Modem Cradle" if the mobile computer is seated in the Modem Cradle. For the Modem Cradle, its physical connectivity can be verified via **System Menu | 3. Tests | 6. Echo Test | MODEM**.
- ▶ Select "via Generic Modem" if you are connecting a generic modem to the mobile computer.

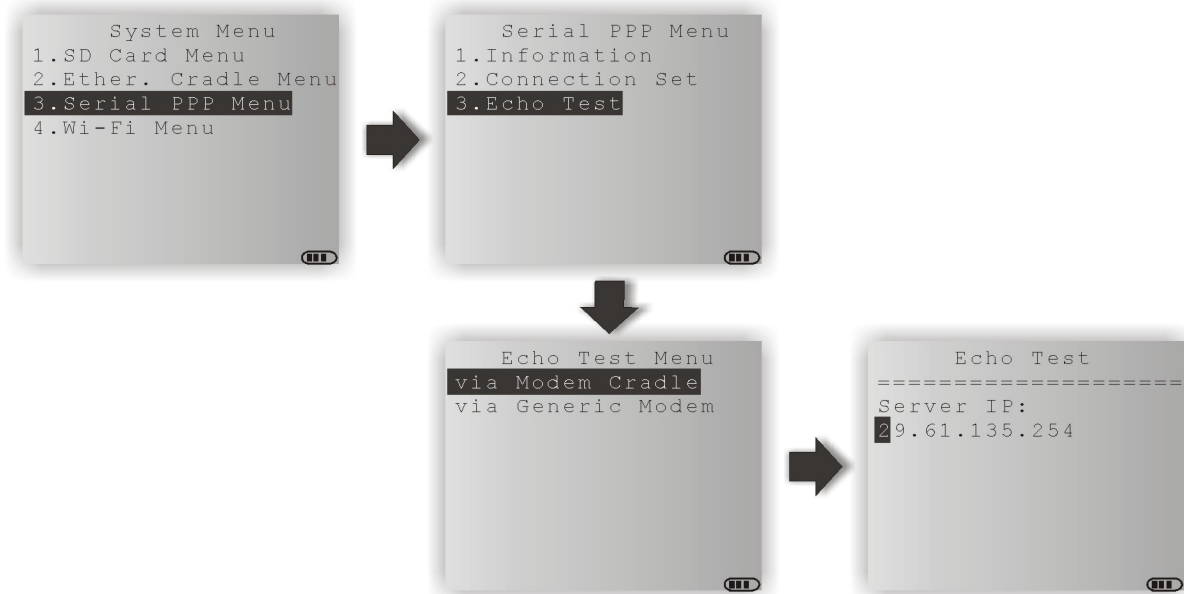

**Note:** Enter the IP address of a server with which a PPP connection is desired. Then, it will try to connect to the server. After the PPP connection is established properly, run the utility "EchoTest.exe" on your computer (TCP/IP - Server), and then, start this test on your mobile computer.

### 3.11 WI-FI MENU

This submenu is for 802.11b/g wireless networking. You must configure these parameters correctly.

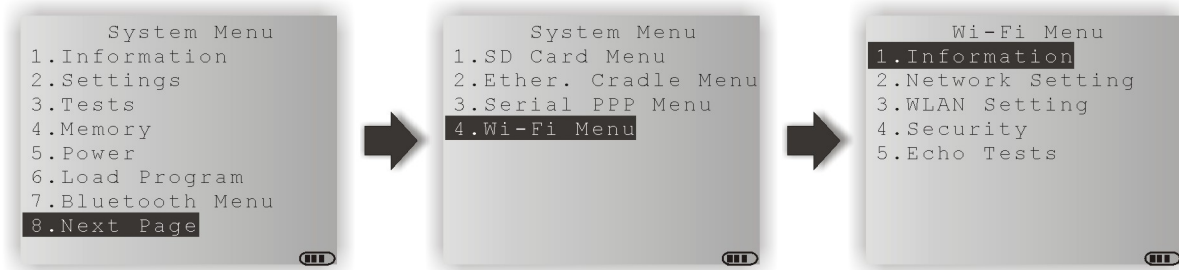

Note: The menu is available only when (1) the Wi-Fi module is present, and (2) the external library 84WLAN.lib is included in your program (.SHX).

| Wi-Fi Settings         | Default Value          | Ad-hoc                          | Infrastructure |
|------------------------|------------------------|---------------------------------|----------------|
| <b>Network Setting</b> |                        | <b>Items Need to Be Checked</b> |                |
| DHCP                   | Enable                 | ---                             | v              |
| SubNet Mask            | 255.255.128.0          | v                               | v              |
| Local IP Address       | 0.0.0.0                | v                               | v              |
| Default Gateway        | 0.0.0.0                | ---                             | v              |
| DNS Server             | 0.0.0.0                | ---                             | v              |
| Domain Name            | ---                    | ---                             | v              |
| <b>WLAN Setting</b>    |                        |                                 |                |
| Local Name             | Model no. + Serial no. | v                               | v              |
| SS ID                  | ---                    | ---                             | v              |
| System Scale           | Medium                 | ---                             | v              |
| Power Saving           | Enable                 | ---                             | v              |
| Preamble               | Long                   | ---                             | v              |
| Ad-Hoc                 | Disable                | v                               | ---            |
| Fixed BSSID            | 000000000000           | ---                             | v              |
| <b>Security</b>        |                        |                                 |                |
| Authentication         | Open System            | ---                             | v              |
| WEP Menu               | Disable                | ---                             | v              |
| EAP Menu               | Disable                | ---                             | v              |
| WPA Menu               | Disable                | ---                             | v              |



### 3.11.1 INFORMATION

Information of network configuration can be viewed here.

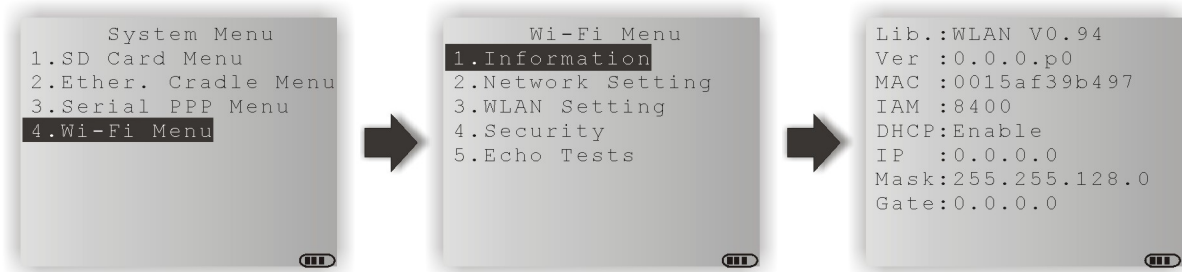

#### Wi-Fi Menu | 1. Information

|             |   |
|-------------|---|
| <b>Lib</b>  | Wi-Fi library version   |
| <b>Ver</b>  | Firmware version of the Wi-Fi module  |
| <b>MAC</b>  | MAC address of the Wi-Fi module   |
| <b>IAM</b>  | A name given to the mobile computer for identification. <ul style="list-style-type: none"> <li>▶ By default, it is made up of model number and the serial number.<br/>(Identical to 3. WLAN Setting   1. Local Name)</li> </ul> |
| <b>DHCP</b> | DHCP server in use or not   |
| <b>IP</b>   | IP address of the mobile computer   |
| <b>Mask</b> | Subnet Mask   |
| <b>Gate</b> | Default Gateway   |

### 3.11.2 NETWORK SETTING

Set parameters for IP networking.

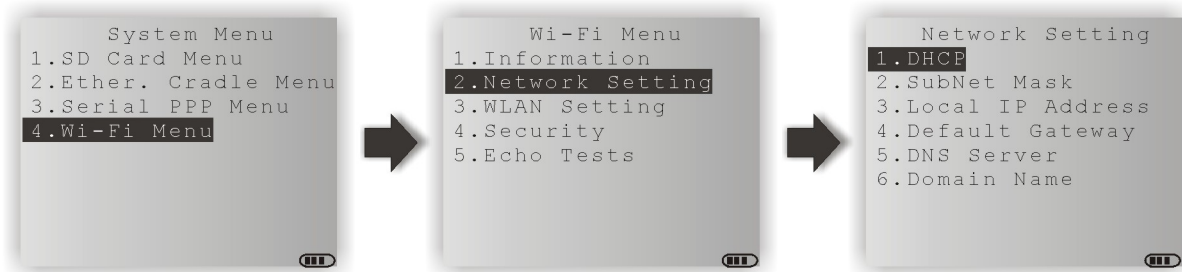

---

#### DHCP

Options — Enable or Disable

---

#### Subnet Mask

Enter a new Mask IP, if necessary.

---

#### Local IP Address

Enter a new address for the mobile computer, if necessary.

---

#### Default Gateway

Enter a new address for the default Gateway, if necessary.

---

#### DNS Server

Enter a new address for the DNS server, if necessary.

---

#### Domain Name

The domain name of the host is displayed when DHCP server is enabled.

---

**Note:** Normally, DHCP is enabled and all of the settings can be obtained from the DHCP server.

---

### 3.11.3 WLAN SETTING

Wireless networking can operate in two modes – (1) Ad-hoc mode: peer-to-peer, and (2) Infrastructure mode: point to multi-point through access points.

Set the following parameters.

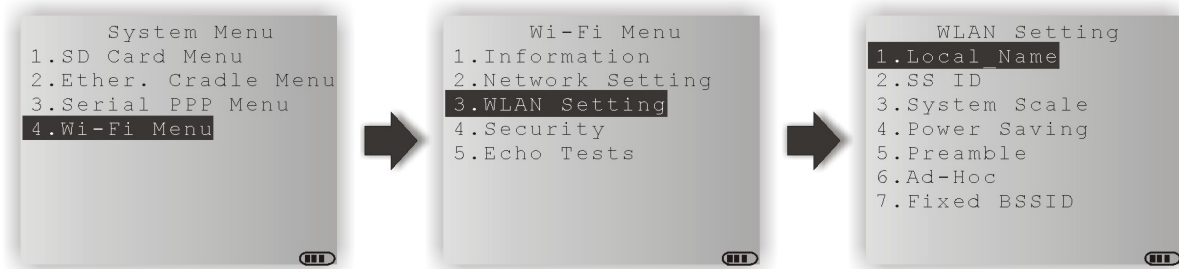

#### Local Name

Enter a name for identifying the mobile computer.

- ▶ By default, it is made up of model number and the serial number.

#### SS ID

This refers to Service Set Identifier or AP name, which is used for remote device association.

- ▶ The mobile computer can ONLY communicate with access points that have the same SS ID.

#### System Scale

This refers to Access Point Density.

Options — [1] Low [2] Medium [3] High [4] Customized

- ▶ The value you set must match that set for the access point.
- ▶ “Low / Medium / High” means the mobile computer will search for other APs only when data transmission rate drops below “1 / 2 / 5” Mbps individually.
- ▶ “Customized” lets you set data rate for the mobile computer to search for other APs when data transmission rate drops below the specified value —
  - 802.11b: 1, 2, 5.5, 11 Mbps
  - 802.11g: 1, 2, 5.5, 11 Mbps & 6, 9, 12, 18, 24, 36, 48, 54 Mbps

#### Power Saving

This refers to the low power consumption mode.

Options — Enable or Disable

- ▶ The value you set must match that set for the access point.

#### Preamble

Options — [1] Long [2] Short [3] Both

- ▶ The value you set must match that set for the access point.

### **Ad-Hoc**

---

This refers to peer-to-peer mode, without going through access points.

Options — Enable or Disable

### **Fixed BSSID**

---

This refers to the use of a specific AP's MAC address as the fixed Basic Service Set Identifier.

- ▶ The mobile computer can ONLY communicate with this one and only access point.

### 3.11.4 SECURITY

Set or modify security parameters.

- ▶ WEP:      Wired Equivalent Privacy
- ▶ EAP:      Extensible Authentication Protocol
- ▶ WPA:      Wi-Fi Protected Access

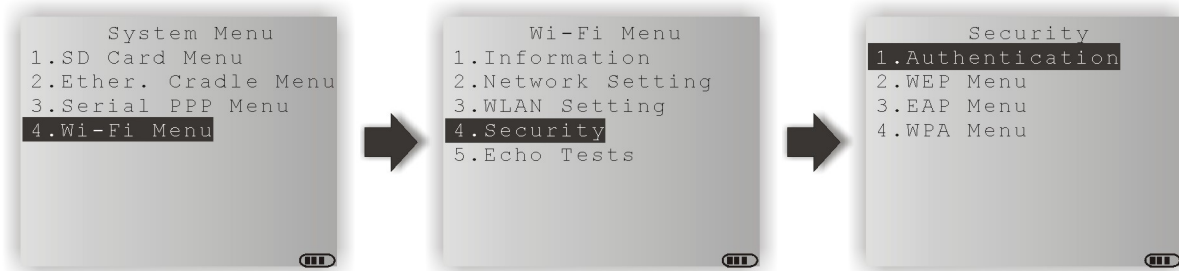

#### Authentication

- |                 |                                       |
|-----------------|---------------------------------------|
| [1] Open System | ▶ Default authentication type         |
| [0] Share Key   | ▶ This requires implementing WEP key. |

#### WEP Menu

- |                |   |
|----------------|---|
| WEP Setting    | ▶ Enable (For Share Key, it must be enabled!)                 |
|                | ▶ Disable (default)   |
| WEP Key Length | ▶ 64 bits   |
|                | ▶ 128 bits (default)  |
| Default Key    | WEP KEY1  |
| WEP Key        | Enter WEP Keys 1 ~ 4 in one of the following input data type: |
|                | ▶ ASCII (up to 13 characters)                                 |
|                | ▶ Hexadecimal (up to 26 characters)                           |

#### EAP Menu (for associating to Cisco access points)

- |              |   |
|--------------|---|
| EAP Setting  | ▶ Enable                                |
|              | ▶ Disable (default)                     |
| EAP ID       | Enter a user name (up to 32 characters) |
| EAP Password | Enter a password (up to 32 characters)  |

#### WPA Menu (WPA-PSK)

- |                |   |
|----------------|---|
| WPA Setting    | ▶ Enable  |
|                | ▶ Disable (default)                                 |
| WPA2 Setting   | ▶ Enable  |
|                | ▶ Disable (default)                                 |
| WPA Passphrase | Enter a phrase as your password (8 ~ 63 characters) |

### 3.11.5 ECHO TESTS

This function is used to measure the coverage of the range, estimate the number of APs and mobile computers needed, and determine the topology of deploying APs.

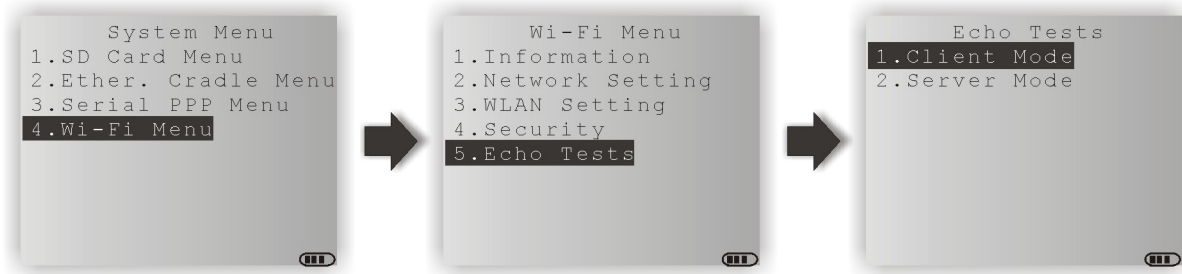

#### Client Mode

Set the mobile computer as a client. Enter the IP address of a server with which a connection is desired. Then, it will try to connect to an AP.

1. Run the utility "EchoTest.exe" on your computer. Associated settings include
  - Select "TCP/IP – Server" for interface.
  - Set Action Mode to "Passive".
2. Start the echo test on both ends.
3. Enter the server IP and port number on the mobile computer.

#### Server Mode



Set the mobile computer as a server. The mobile computer will try to connect to an AP.

1. Run the utility "EchoTest.exe" on your computer. Associated settings include
  - Select "TCP/IP – Client" for interface.
  - Set Action Mode to "Passive".
2. Start the echo test on both ends.

While running echo tests, if WPA setting is enabled for security, the SSID and Passphrase will be processed to generate a pre-share key.

Note: If you change the SSID or Passphrase, it will have to re-generate a pre-share key.

- 1) For initial association with an access point, you will see an antenna icon developing on the screen to indicate that the mobile computer is processing a pre-share key.
- 2) After having generated the pre-share key, the mobile computer proceeds to establish a connection with an access point, and you will see the whole antenna is flashing.
- 3) When the mobile computer has been connected to the access point successfully, you will see the whole antenna and the indication of wireless signal strength.

The changing icon -    indicates 8400 is processing a pre-share key.  
Wait for a few seconds.

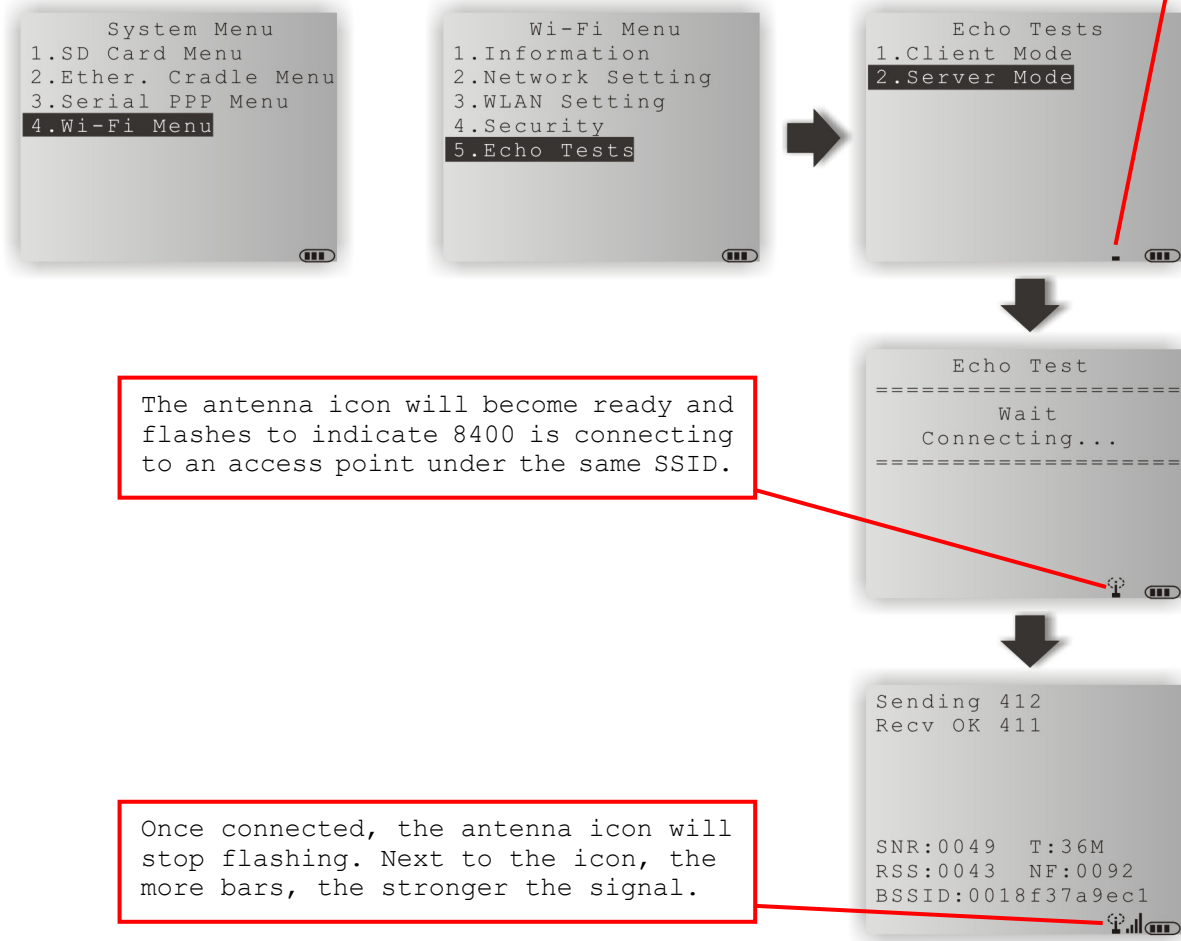

The antenna icon will become ready and flashes to indicate 8400 is connecting to an access point under the same SSID.

Once connected, the antenna icon will stop flashing. Next to the icon, the more bars, the stronger the signal.

Note: If you are programming in C or BASIC, be aware that the antenna icon will appear on the device screen after NetInit() or START TCPIP() is called. (WPA must be enabled first!)

Once the connection of echo test is established, the details will be displayed as illustrated below.

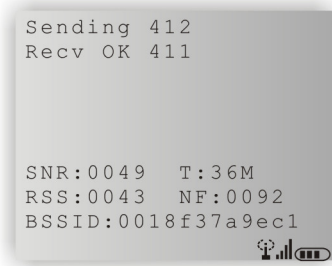

| SNR (dB)                | T                 | RSS (-dBm)                       | NF (-dBm)           |
|-------------------------|-------------------|----------------------------------|---------------------|
| (Signal to Noise ratio) | (Transmit Speed)  | (Received Signal Strength Level) | (Noise Floor Level) |
| 0 ~ 10    Very Poor     | 1            Mbps | 0 ~ 60    Strong                 | 0 ~ 92    Strong    |
| 10 ~ 20    Poor         | 2            Mbps | 60 ~ 75    Moderate              | 92 ~ 98    Moderate |
| 20 ~ 30    Fair         | 5.5         Mbps  | over 75    Weak                  | over 98    Weak     |
| 30 ~ 40    Good         | 11          Mbps  |                                  |                     |
| over 40    Very Good    | 6            Mbps |                                  |                     |
|                         | 9            Mbps |                                  |                     |
|                         | 12          Mbps  |                                  |                     |
|                         | 18          Mbps  |                                  |                     |
|                         | 24          Mbps  |                                  |                     |
|                         | 36          Mbps  |                                  |                     |
|                         | 48          Mbps  |                                  |                     |
|                         | 54          Mbps  |                                  |                     |



## PROGRAM MANAGER & KERNEL

---

This chapter explains **Program Manager** and **Kernel** that manage multiple programs and firmware upgrade.

### IN THIS CHAPTER

---

|                           |    |
|---------------------------|----|
| 4.1 Program Manager ..... | 79 |
| 4.2 Kernel .....          | 84 |

### 4.1 PROGRAM MANAGER

The mobile computer supports multiple applications and languages. In the menu of **Program Manager**, it allows storing up to eight programs and has one activated for the current use.

If there is no application program exists, **Program Manager** will be displayed after you turn on the mobile computer.

---

Warning! Program Manager is provided for managing programs in an administrative level.

---

#### How to access Program Manager?

---

- 1) Turn off the mobile computer.
- 2) Press [8] + [Power].



### 4.1.1 DOWNLOAD

Here provides a full list of programs that are currently stored on the mobile computer with size information. Multiple application programs can be downloaded through a variety of interfaces. Upon completion of downloading, you are allowed to input a name for the program. If there is no need to rename the program, simply press [ENTER] to leave as it is.

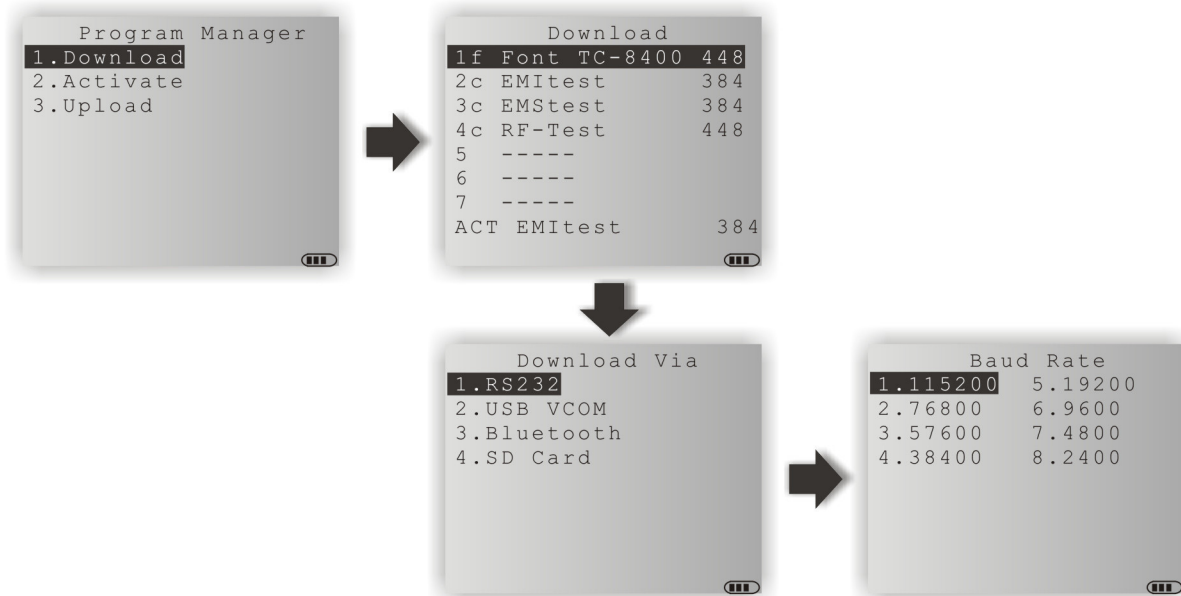

The length of program name can be up to 12 characters. Program size is in kilobytes.

A suffix letter after the memory sector (1 ~ 7) indicates the file type of program.



- ▶ "b" for BASIC program (.SYN)
- ▶ "c" for C program (.SHX)
- ▶ "f" for font file (.SHX)

Note: (1) For a BASIC program (.SYN), it can only be downloaded via **System Menu**.  
 (2) In addition to the system font, there can be only one font file downloaded to the mobile computer. The custom font file needs to be downloaded via **System Menu** or **Kernel Menu**.

## SPARE MEMORY SECTORS (1 ~ 7)



Additional program files can be directly downloaded to these sectors.

### Download a program file to an empty sector:

1. Press the arrow keys  (Up)  (Down) to select an empty sector, and then press [ENTER].
2. Select a desired interface for downloading.
3. Connect the interface cable if required, and wait for a few seconds to establish a connection...
4. To abort the action, press [ESC]. Then press [ESC] again to return to the menu.

### Download a program file to an occupied sector:

If no available sectors, you'll have to replace one program with the new one.

1. Press the arrow keys  (Up)  (Down) to select a program that you want to delete, and then press [ENTER].
2. The program information is displayed on the screen.

Press the blue modifier key ( or ) to enter the Alpha mode:

- ▶ Press the capital letter [C] and follow the steps below to download a program file.
- ▶ Press the capital letter [D] if you simply want to delete the program.

3. Select a desired interface for downloading.
4. Connect the interface cable if required, and wait for a few seconds to establish a connection...
5. To abort the action, press [ESC]. Then press [ESC] again to return to the menu.

From the menu, you'll see the program has been deleted but no new program is present (because you have canceled the download action).

## ACTIVE MEMORY SECTOR ("ACT")

Only the application program, which needs to be activated immediately, can be downloaded to the active memory sector.

### Download to Memory Sector "ACT":

1. Press the arrow key  to select the memory sector "ACT" (may be unoccupied), and then press [ENTER].
2. Select a desired interface for downloading.
3. Connect the interface cable if required, and wait for a few seconds to establish a connection...

If the active memory sector has already been occupied by an application program, the newly downloaded program will replace the currently active program and come into effect immediately.

## 4.1.2 ACTIVATE

The list shows the entire spare programs stored on the mobile computer. From the list, you can select from the memory sector (1 ~ 7) or SD card. The selected program will be copied to the active memory sector and replace the current one.

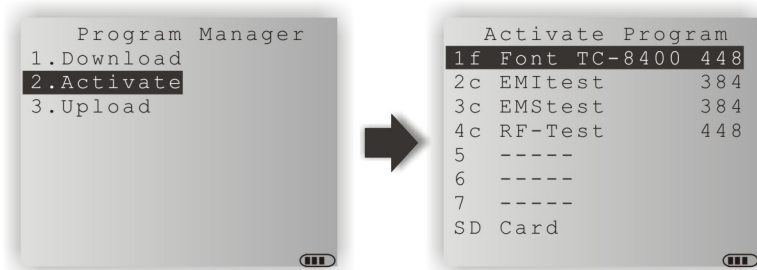

Note: A font file cannot be activated.

### TO CLEAR FILE SYSTEM

When <New Program Start> screen appears, "Press [ESC] to clear file" means the file system in the SRAM will be cleared out by pressing [ESC]. Then there will be no data (transactions, settings, etc.) stored on the mobile computer when the new program comes into effect.

### TO KEEP FILE SYSTEM

To keep the data, simply press any other key.

### 4.1.3 UPLOAD

You may duplicate one or all of the programs from the mobile computer to a host computer or another mobile computer. This can be used to clone software on mobile computers.

Note: To clone all of the programs, the target mobile computer cannot have any other program downloaded except the active one; that is, Memory Sectors 1 ~ 7 must be empty!

The procedures are similar to that for downloading programs.

- ▶ If the target is "Terminal", the interface options "USB Virtual COM" and "SD Card" are unavailable.
- ▶ If the target is "PC", the interface option "SD Card" is unavailable.

This screen is not available if you select "2.All Programs" from the previous screen.

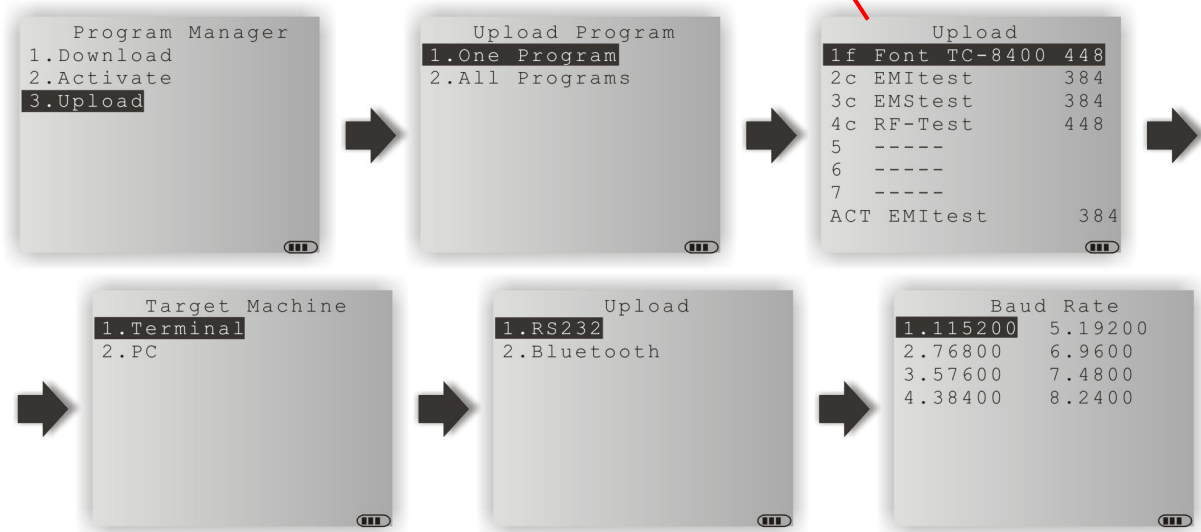

## 4.2 KERNEL

The kernel resides in the innermost core of the system. It has the highest security and is always protected by the system. When the application program is corrupted and **System Menu** fails at the same time, **Kernel Menu** provides an access to fix the system.

---

**Warning!** Kernel Menu is NOT for the use of any end users.

---

### How to access Kernel Menu?

---

- 1) When the last session is in **System Menu** or **Program Manager**, simply turn off the mobile computer. Otherwise, you must reload the battery pack.
- 2) Press [1] + [7] + [Power].



## 4.2.1 KERNEL INFORMATION

Here provides important system information to help diagnose the system.

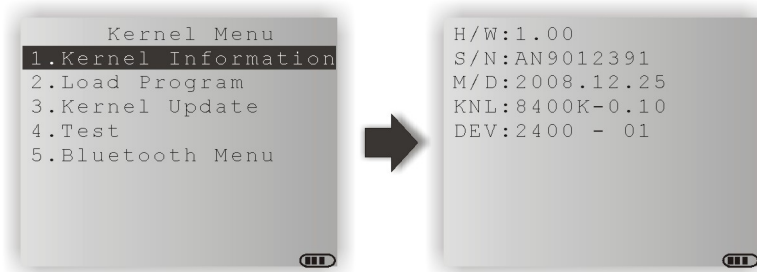

### Kernel Menu | 1. Information

|            |   |
|------------|---|
| <b>H/W</b> | Hardware version                                  |
| <b>S/N</b> | Serial number of the mobile computer              |
| <b>M/D</b> | Manufacturing date                                |
| <b>KNL</b> | Kernel version                                    |
| <b>DEV</b> | 6-digit code for optional hardware configurations |

Refer to [Understanding Device Code](#).

## 4.2.2 LOAD PROGRAM

You can download one program file to the active memory sector, as well as one font file to the memory address assigned by the system. After downloading, restart the mobile computer to activate the new program. Refer to [Appendix I Download Utility](#).

- ▶ New application program or program update
- ▶ And/or one font file, i.e. multi-language font

If you are using a custom font file rather the system font and you want to download another font file, it is necessary to delete the current font file from the program list displayed by [Program Manager](#) first. Otherwise, downloading new font file is not allowed.

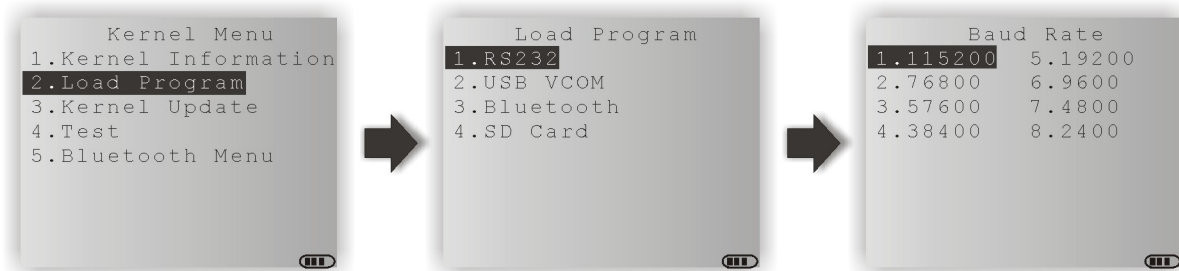

Note: The mobile computer will stay in download mode for approximately 30 seconds.

| .SHX Program        | Download one of the following C program files and/or font file: |  |
|---------------------|---|--|
| <b>Program File</b> | ▶ AG Runtime:   | U8400.shx (Batch AG)<br>WU8400.shx (WLAN AG)                 |
|                     | ▶ CipherNet Runtime:  | 84xx-5250.shx (CipherNet-5250)<br>84xx-VT.shx (CipherNet-VT) |
|                     | ▶ BASIC Runtime <sup>Note</sup> :                               | B8400.shx  |
|                     | ▶ User program  |  |
| <b>Font File</b>    | Refer to the Font Files folder on CD-ROM.                       |  |

If you have downloaded a BASIC Runtime program, the next time you access the [Load Program](#) service via **System Menu**, you will be able to select whether to download a C program (.SHX) or BASIC program (.SYN).

Note: Go to **System Menu | 6. Load Program | 2. Load Basic**, and download a BASIC program (\*SYN).



---

**SETTINGS**
**Interface**

| Options   | Description   |
|-----------|---|
| RS232     | Proceed to configure baud rate settings on your computer and the mobile computer. |
| USB VCOM  | Connect the USB cable between your computer and the mobile computer.              |
| Bluetooth | Approach the target Bluetooth enabled device.                                     |
| SD Card   | This option is available only when the memory card is present.                    |

**Baud Rate**



| Options      | Supported by CipherLab software, including download utilities |    |
|--------------|---|----|
| 115200 (bps) | Yes   |    |
| 76800 (bps)  |   | No |
| 57600 (bps)  | Yes   |    |
| 38400 (bps)  | Yes   |    |
| 19200 (bps)  | Yes   |    |
| 9600 (bps)   | Yes   |    |
| 4800 (bps)   |   | No |
| 2400 (bps)   |   | No |

---

**LOAD PROGRAM VIA BLUETOOTH**

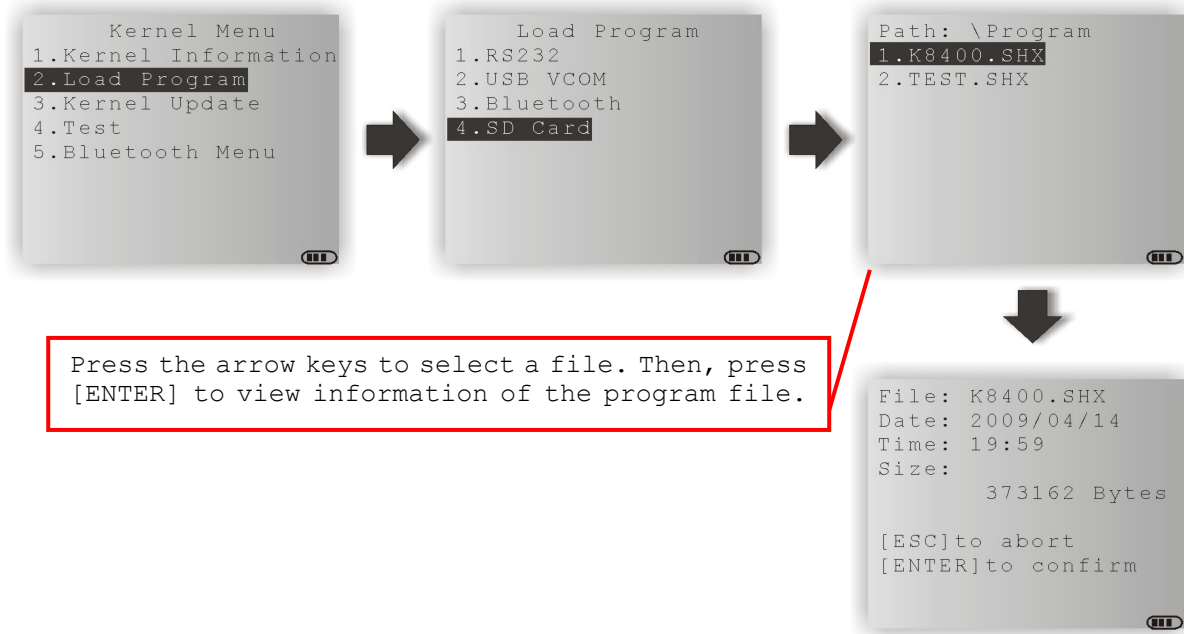
- 1) Go to **Kernel Menu | 5. Bluetooth Menu | 3. Security**, and configure the following Bluetooth settings first.
  - ▶ Authentication
  - ▶ PIN code
- 2) Go to **Kernel Menu | 2. Load Program** and select Bluetooth.
- 3) Start the pairing procedure from your computer, for example, click [Pair Device] and/or [Connect Bluetooth Serial Port].
- 4) Run the download utility: ProgLoad.exe
  - Select interface RS-232 for using Bluetooth SPP.
  - Select COM port properties that match with the serial port settings used on your computer.

**LOAD PROGRAM VIA SD CARD**

- 1) If you have copied the desired program file(s) to your SD card, go to **Kernel Menu | 2. Load Program** and select SD Card. You will see a list of all the files under the directory “\Program”, as shown above.
- 2) Press the arrow keys   to select a file.
- 3) Press [ENTER] to view information of the program file.
- 4) Press [ENTER] to confirm downloading the program file to the mobile computer.  
Press [ESC] to abort the download task.

### 4.2.3 KERNEL UPDATE

The kernel might need to be updated to improve performance or due to other considerations.

- ▶ To download a kernel update (K\*.shx), the procedure is the same as that for downloading a program.
- ▶ Any attempt to download an older version will be rejected.
- ▶ The system will restart itself right after downloading.

**Warning:** Do not turn off the mobile computer while downloading a kernel update or re-starting the mobile computer. Otherwise, it will crash the kernel forever. There is no way to recover it!

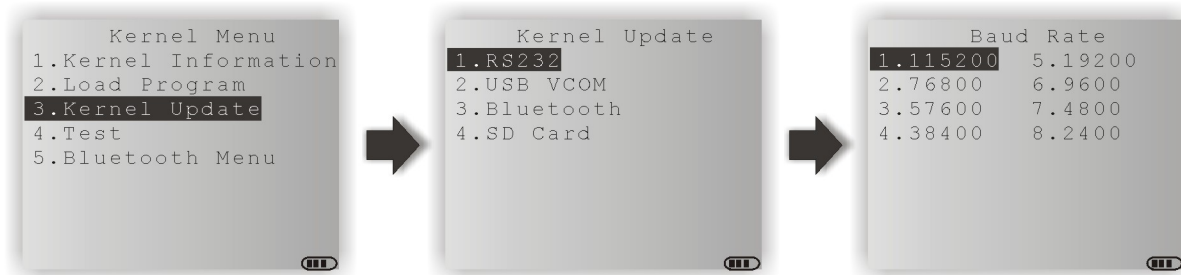

**Note:** CipherLab software, including download utilities, supports the following baud rate options: 115200/57600/38400/19200/9600 bps.

## 4.2.4 TEST & CALIBRATE

This tool is provided for manufacturing use.

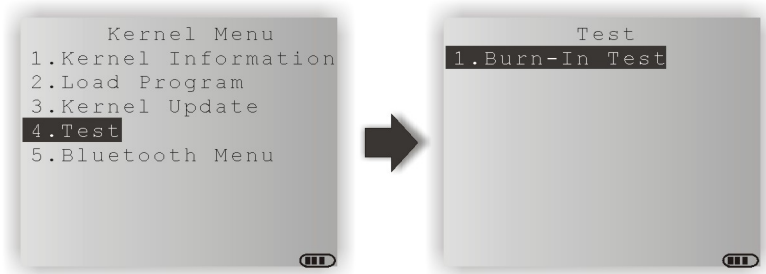

---

**Warning!** You should not perform this test.

---

## 4.2.5 BLUETOOTH MENU

Refer to [3.7 Bluetooth Menu](#) for details. This submenu is almost the same as the one provided in **System Menu** except for a few items.

# SPECIFICATIONS

| Model Designation                 |                    | 8400  | 8470 |  |  |
|-----------------------------------|--------------------|---|------|--|--|
| <b>Wireless Communications</b>    | Bluetooth Class 2  | √   | √    |  |  |
|                                   | 802.11b/g          |   | √    |  |  |
| <b>Readers</b>                    | Barcode Reader     | <ul style="list-style-type: none"> <li>▶ CCD (linear imager)</li> <li>▶ Standard Laser</li> <li>▶ 2D Imager</li> </ul>  |      |  |  |
| <b>Electrical Characteristics</b> | Main Battery       | Rechargeable Li-ion battery – 3.7 V, 1800 mAh   |      |  |  |
|                                   | Working Time       | Laser, one scan per 5 seconds, without backlight: <ul style="list-style-type: none"> <li>▶ 110 hours in batch mode</li> <li>▶ 35 hours in Wi-Fi mode</li> <li>▶ 65 hours in Bluetooth mode</li> </ul>   |      |  |  |
|                                   | Backup Battery     | <ul style="list-style-type: none"> <li>▶ Rechargeable Lithium button cell – 3.0 V, 18 mAh</li> <li>▶ Data retention – at least 25 days</li> </ul>   |      |  |  |
|                                   | Power Adaptor      | <ul style="list-style-type: none"> <li>▶ Input: AC 100~240 V, 50/60 Hz</li> <li>▶ Output: DC 5 V, 3 A</li> <li>▶ Operating Temperature: 0 °C to 40 °C</li> </ul>  |      |  |  |
| <b>Physical Characteristics</b>   | CPU                | 32-bit Toshiba CMOS type, 60 MHz  |      |  |  |
|                                   | Memory             | <ul style="list-style-type: none"> <li>▶ Program memory – 4 MB flash</li> <li>▶ Data memory – onboard SRAM, options include 4 or 16 MB</li> </ul>   |      |  |  |
|                                   | Display            | Graphic LCD, 160 x 160 pixels, FSTN with LED backlight programmable <ul style="list-style-type: none"> <li>▶ Font size 6x8: 26 characters by 18 lines</li> <li>▶ Font size 8x16: 20 characters by 9 lines</li> <li>▶ Font size 12x12: 13 characters by 12 lines</li> <li>▶ Font size 16x16: 10 characters by 9 lines</li> </ul> |      |  |  |
|                                   | Keypad             | 29 or 39 rubber keys, LED backlight programmable  |      |  |  |
|                                   | Indicators         | <ul style="list-style-type: none"> <li>▶ Two dual-color LEDs – red/green and blue/green, programmable</li> <li>▶ Buzzer – 2.7 KHz, programmable</li> </ul>  |      |  |  |
|                                   | Vibrator           | 0.45G, programmable   |      |  |  |
|                                   | Expansion Slot     | microSDHC, up to 8 GB   |      |  |  |
|                                   | Enclosure Material | Rubber & ABS plastic  |      |  |  |
|                                   | Dimensions         | 171 mm (L) 72 mm (W) 41 mm (H)  |      |  |  |
|                                   | Weight             | Approx. 295 g (Laser, battery included)   |      |  |  |

|                                      |                          |   |
|--------------------------------------|--------------------------|---|
| <b>Environmental Characteristics</b> | Temperature              | Operating: -10 °C to 60 °C<br>Storage: -20 °C to 70 °C  |
|                                      | Humidity                 | Operating: 10% to 90% non-condensing<br>Storage: 5% to 95% non-condensing   |
|                                      | Impact Resistance        | 1.5 m, 5 drops per 6 sides  |
|                                      | Tumble Test              | 1000 times at 1 meter   |
|                                      | Splash / Dust Resistance | IP 54   |
|                                      | Electrostatic Discharge  | ± 15 kV air discharge, ± 8 kV contact discharge   |
| <b>Programming</b>                   | Development Tools        | C and BASIC   |
|                                      | Software & Utilities     | FORGE Application Generator (AG), AG utilities;<br>MIRROR Emulator (CipherNet) for VT100/220, IBM 5250 emulation;<br>Download utilities, testing tools, etc.  |
| <b>Accessories</b>                   |                          | <ul style="list-style-type: none"> <li>▶ Protective Cover</li> <li>▶ Spare rechargeable battery pack</li> <li>▶ 4-slot Battery Charger</li> <li>▶ RS-232 Charging &amp; Communication Cable</li> <li>▶ 308 USB Virtual COM Interface Cable (convert RS-232 to USB)</li> <li>▶ Charging &amp; Communication Cradle</li> <li>▶ Modem Cradle (Auto-detect)</li> <li>▶ Ethernet Cradle (10/100 BASE-T)</li> <li>▶ GPRS/GSM Cradle (EDGE/Quad-band)</li> </ul> |

## DOWNLOAD UTILITY

For easy development of applications, the mobile computer ships with **FORGE Application Generator** programs, batch and WLAN versions, as well as a download utility.

### FILE TYPES

Depending on the file type, you may download a program or font file via **System Menu**, **Program Manager** or **Kernel Menu**.

| File Type         | System Menu | Kernel Menu | Program Manager |
|-------------------|-------------|-------------|-----------------|
| Font file         | √           | √           | –               |
| AG runtime        | √           | √           | √               |
| CipherNet runtime | √           | √           | √               |
| Kernel update     | –           | √           | –               |
| BASIC program     | √           | –           | –               |
| BASIC runtime     | √           | √           | √               |

### FONT FILE

Download a font file (.SHX) via **System Menu** or **Kernel Menu**.

- ▶ Font file: Font-Multi-Language.SHX, Font-Japanese.SHX, and so on.

### C PROGRAMS

Download a C program (.SHX) via **System Menu**, **Program Manager** or **Kernel Menu**.

- ▶ AG runtime: U8400.SHX, WU8400.SHX
- ▶ CipherNet runtime: 84xx-VT.SHX, 84xx-5250.SHX
- ▶ Kernel update: K\*.SHX

Note: You can only download a Kernel update via **Kernel Menu**.

### BASIC PROGRAMS

First, download a BASIC runtime (e.g. B8400.SHX) via **System Menu**, **Program Manager** or **Kernel Menu**. Then, it will allow you to download a BASIC program (.SYN) via **System Menu**.

## PROGLOAD.EXE

The utility "ProgLoad.exe" is provided for you to download a program (\*.SHX or \*.SYN) to the mobile computer. Run the program on your computer. The following dialog box pops up.

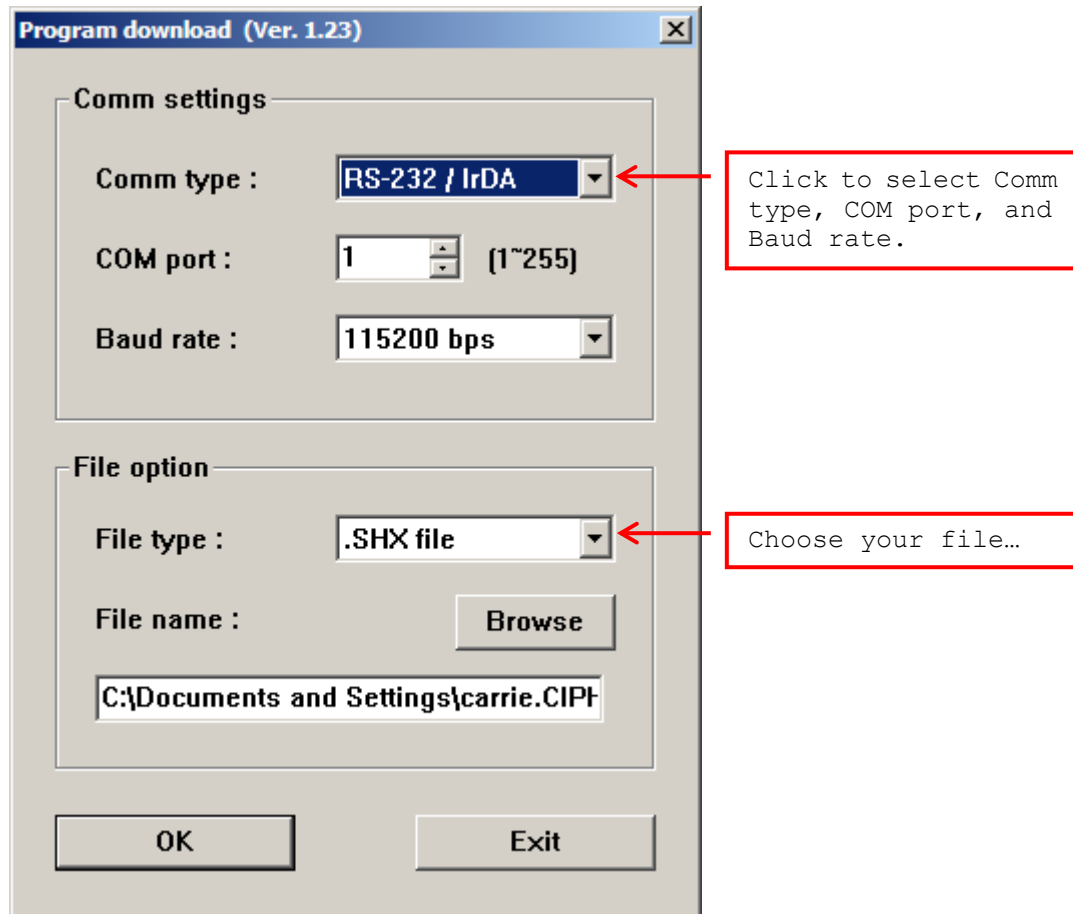

### Communication Type

|             |   |
|-------------|---|
| RS-232/IrDA | Connection via direct RS-232 cable, IrDA port, or Bluetooth SPP |
| Cradle-IR   | Connection via cradle   |
| TCP/IP      | Connection over networks  |

### File Type

|           |   |
|-----------|---|
| .SHX file | Any C program, such as AG Runtime, BASIC Runtime, font file, etc. |
| .SYN file | Any BASIC program after BASIC Runtime has been installed first.   |

Note: (1) For 8400, USB Virtual COM shares the interface option of RS-232/IrDA.  
 (2) Cradle-IR is not supported on 8400.



### TROUBLESHOOTING

---

#### CANNOT TURN ON WHEN PRESSING POWER KEY

- ▶ Make sure the battery pack is installed properly.
- ▶ Re-charge the battery inside the mobile computer and monitor the charging status. (See [3.5 Power.](#))
- ▶ If the battery is faulty, replace it with a fresh and fully charged battery then.

#### CHARGING ERROR

- ▶ If using the USB cable for direct charging, make sure a suitable charging current is selected. (See [3.2.9 USB Charge Current.](#))
- ▶ If joining the power adaptor to the USB or RS-232 cable, make sure it is well connected between the power jack and an outlet.
- ▶ If using a cradle or charger, make sure the power cord is well connected the cradle/charger and an outlet.
- ▶ Check if the battery contacts of the battery itself and the battery compartment are clean.
- ▶ Try to re-charge the battery and monitor the charging status.

---

**Warning!** Only use batteries or charging device manufactured by CipherLab. The use of wrong battery or charging device could result in damage to human body or the product itself, and will void your warranty.

---

#### BUZZER SEEMS NOT WORKING

- ▶ Perform the buzzer test. (See [3.3.2 Buzzer.](#))
- ▶ If the problem persists, reload the battery pack and perform the test again.

#### LED INDICATORS SEEM NOT WORKING

- ▶ Perform the LCD & LED test. (See [3.3.3 LCD & LED.](#))
- ▶ If the problem persists, reload the battery pack and perform the test again.

#### LCD SEEMS NOT WORKING

- ▶ Perform the LCD & LED test. (See [3.3.3 LCD & LED.](#))
- ▶ If the problem persists, reload the battery pack and perform the test again.

### KEYPAD SEEMS NOT WORKING

- ▶ Perform the keyboard test. (See [3.3.4 Keyboard](#).)
- ▶ If the problem persists, reload the battery pack and perform the test again.

### VIBRATOR SEEMS NOT WORKING

- ▶ Perform the vibrator test. (See [3.3.7 Vibrator](#).)
- ▶ If the problem persists, reload the battery pack and perform the test again.

### MOBILE COMPUTER SEEMS NOT WORKING

- ▶ Upload all data to the host and perform the memory test. (See [3.3.5 Memory](#).)
- ▶ If the problem persists, reload the battery pack and perform the test again.

### CANNOT SCAN BARCODES

#### LOW BATTERY CONDITION

- ▶ Check if the battery icon on the screen indicates a low battery status. If so, replace it with a fresh battery then.
- ▶ If the problem persists, check if the battery contacts get dirty or the battery pack does not fit to the compartment.

#### BARCODE READER PROBLEM

- ▶ Perform the reader test to see if the reader is working. (See [3.3.1 Reader](#).)
- ▶ If the problem persists, reload the battery pack and perform the test again.

### CANNOT DECODE DATA AFTER SCANNING

#### UNREADABLE BARCODE

- ▶ Check if the barcode is defaced. A defaced barcode may not be readable.

#### UN-PROGRAMMED TO READ

- ▶ Check if the scanner is programmed to read the symbologies (types of barcode) that you are trying to read.
- ▶ Try scanning a test barcode of the symbology you are trying to read.

#### DIRTY SCAN WINDOW

- ▶ Check if the scan window gets dirty. Wipe it with a clean and dry cloth, and try again.

## OUT OF SCANNING RANGE

- ▶ Try adjusting the scanning distance from the scanner to the barcode.

## CANNOT TRANSMIT/RECEIVE DATA

### USING RS-232 CABLE

- ▶ Check if the RS-232 connection is correct and secured.
- ▶ Make sure the serial port parameters on the host are configured to match the serial parameters on the mobile computer. Try to establish connection again.
- ▶ If the problem persists, run the Echo Test to check if the RS-232 interface between the mobile computer and the host is working. (See [3.3.6 Echo Test.](#))

### USING USB CABLE

- ▶ Check if the USB connection is correct and secured.
- ▶ Check if the USB driver has been installed. Driver version 5.3 or later is required.
- ▶ If the problem persists, run the Echo Test to check if the USB interface between the mobile computer and the host is working. (See [3.3.6 Echo Test.](#))

Note: (1) If you are using USB Virtual COM for the first time, you must install its driver from the CD-ROM. Driver version 5.3 or later is required. Please remove older versions! The virtual COM port will not be assigned until the USB port is in use. (2) For Standard USB cable, it will release COM port in the following conditions: (i) detach the cable from the mobile computer directly, (ii) detach the cable from the cradle directly, (iii) when the cable is attached to the cradle, take away the mobile computer, (iv) the mobile computer is turned off, (v) no application is running on the mobile computer, or COM port is shut down. For applications that require COM port to be occupied all the time, it is suggested to use 308 USB Virtual COM Interface cable instead.

### VIA BLUETOOTH

- ▶ Make sure the distance between the mobile computer and a target device is within proper range. Try to establish connection again.
- ▶ Check if the relevant settings are correct. (See [3.7 Bluetooth Menu.](#))
- ▶ If the problem persists, run the Echo Test to check if the connection is working properly. (See [3.7.4 Echo Tests.](#))

### VIA WI-FI

- ▶ Make sure the mobile computer is connected to an access point properly, under the same SSID. Try to establish connection again.
- ▶ Check if the relevant settings are correct. (See [3.11 Wi-Fi Menu.](#))
- ▶ If the problem persists, run the Echo Test to check if the connection is working properly. (See [3.11.5 Echo Tests.](#))

### VIA ETHERNET CRADLE

- ▶ Check if the Ethernet connection is correct and secured.
- ▶ Make sure the networking parameters are configured properly. Try to establish connection again.
- ▶ Make sure the mobile computer is well seated inside the cradle. DO NOT remove the mobile computer or disconnect the cradle before communications are done.
- ▶ If the problem persists, run the Echo Test to check if the Ethernet connection is working properly. (See [3.9.3 Echo Tests](#).)

### VIA MODEM CRADLE

- ▶ Check if the modem connection is correct and secured.
- ▶ Make sure the modem parameters are configured properly. Try to establish connection again.
- ▶ Make sure the mobile computer is well seated inside the cradle. DO NOT remove the mobile computer or disconnect the cradle before communications are done.
- ▶ If the problem persists, run the Echo Test to check if the PPP connection is working properly. (See [3.10.3 Echo Test](#).)
- ▶ If the problem persists, run the Echo Test to check if the MODEM interface between the mobile computer and the cradle is working. (See [3.3.6 Echo Test](#).)

## KEY REFERENCE TABLES

### 29-KEY KEYPAD

#### SYSTEM DEFAULTS

| Key | Blue key pressed once | Blue key pressed twice | Key  | Orange key pressed once | Orange key pressed twice |
|-----|-----------------------|------------------------|------|-------------------------|--------------------------|
| 1   | @                     | @                      | F1   | F5                      | F1                       |
| 2   | ABC                   | abc                    | F2   | F6                      | F2                       |
| 3   | DEF                   | def                    | F3   | F7                      | F3                       |
| 4   | GHI                   | ghi                    | F4   | F8                      | F4                       |
| 5   | JKL                   | jkl                    | SP   | Tab                     | SP                       |
| 6   | MNO                   | mno                    | BkSp | Del                     | BkSp                     |
| 7   | PQRS                  | pqrs                   |      |                         |                          |
| 8   | TUV                   | tuv                    |      |                         |                          |
| 9   | WXYZ                  | wxyz                   |      |                         |                          |
| 0   | /*                    | /*                     |      |                         |                          |
| -   | +\$                   | +\$                    |      |                         |                          |
| .   | %#                    | %#                     |      |                         |                          |



**EXTENDED FUNCTION KEYS**

| Key | Blue key pressed once | Blue key pressed twice | Key  | Orange key pressed once | Orange key pressed twice |
|-----|-----------------------|------------------------|------|-------------------------|--------------------------|
| 1   | @                     | @                      | 1    | F11                     | 1                        |
| 2   | ABC                   | abc                    | 2    | F12                     | 2                        |
| 3   | DEF                   | def                    | 3    | F13                     | 3                        |
| 4   | GHI                   | ghi                    | 4    | F14                     | 4                        |
| 5   | JKL                   | jkl                    | 5    | F15                     | 5                        |
| 6   | MNO                   | mno                    | 6    | F16                     | 6                        |
| 7   | PQRS                  | pqrs                   | 7    | F17                     | 7                        |
| 8   | TUV                   | tuv                    | 8    | F18                     | 8                        |
| 9   | WXYZ                  | wxyz                   | 9    | F19                     | 9                        |
| 0   | /*                    | /*                     | 0    | F20                     | 0                        |
| -   | +\$                   | +\$                    | -    | F9                      | -                        |
| .   | %#                    | %#                     | .    | F10                     | .                        |
|     |                       |                        | F1   | F5                      | F1                       |
|     |                       |                        | F2   | F6                      | F2                       |
|     |                       |                        | F3   | F7                      | F3                       |
|     |                       |                        | F4   | F8                      | F4                       |
|     |                       |                        | SP   | Tab                     | SP                       |
|     |                       |                        | BkSp | Del                     | BkSp                     |

Extended Function Keys must be enabled through programming!

**39-KEY KEYPAD**

**SYSTEM DEFAULTS**

| Key | Blue key pressed once | Blue key pressed twice | Key | Orange key pressed once   | Orange key pressed twice |
|-----|-----------------------|------------------------|-----|---|--------------------------|
| 1   | A                     | a                      | 1   | :   | 1                        |
| 2   | B                     | b                      | 2   | ;   | 2                        |
| 3   | C                     | c                      | 3   | ,   | 3                        |
| +   | D                     | d                      | +   | =   | +                        |
| 4   | E                     | e                      | 4   | <   | 4                        |
| 5   | F                     | f                      | 5   | >   | 5                        |
| 6   | G                     | g                      | 6   | (   | 6                        |
| -   | H                     | h                      | -   | )   | -                        |
| 7   | I                     | i                      | 7   | \$  | 7                        |
| 8   | J                     | j                      | 8   | ?   | 8                        |
| 9   | K                     | k                      | 9   | &   | 9                        |
| *   | L                     | l                      | *   | @   | *                        |
| .   | M                     | m                      | .   |  | .                        |
| 0   | N                     | n                      | 0   |  | 0                        |
| #   | O                     | o                      | #   | %   | #                        |
| /   | P                     | p                      | /   | \   | /                        |

| <b>Key</b> | <b>Blue key<br/>pressed<br/>once</b> | <b>Blue key<br/>pressed<br/>twice</b> | <b>Key</b> | <b>Orange key<br/>pressed<br/>once</b> | <b>Orange key<br/>pressed<br/>twice</b> |
|------------|--------------------------------------|---------------------------------------|------------|--|---|
| F1         | Q                                    | q                                     | F1         | F11                                    | F1                                      |
| F2         | R                                    | r                                     | F2         | F12                                    | F2                                      |
| F3         | S                                    | s                                     | F3         | F13                                    | F3                                      |
| F4         | T                                    | t                                     | F4         | F14                                    | F4                                      |
| F5         | U                                    | u                                     | F5         | F15                                    | F5                                      |
| F6         | V                                    | v                                     | F6         | F16                                    | F6                                      |
| F7         | W                                    | w                                     | F7         | F17                                    | F7                                      |
| F8         | X                                    | x                                     | F8         | F18                                    | F8                                      |
| F9         | Y                                    | y                                     | F9         | F19                                    | F9                                      |
| F10        | Z                                    | z                                     | F10        | F20                                    | F10                                     |
|            |                                      |                                       | SP         | Tab                                    | SP                                      |
|            |                                      |                                       | BkSp       | Del                                    | BkSp                                    |